

A B Y S STM

u s e r ' s m a n u a l



MARTIN LOGAN[®]
the loudspeaker technology company

CONTENTS

Contents	2
Installation in Brief	3
Introduction	4
About the Controls	5
Connections and Control Settings	6
Before Connecting the Abyss	
2-Channel Mode	
Multi-Channel Mode	7
2-Channel/Multi-Channel Mode	8
2-Channel Using Speaker Level Inputs	9
2-Channel Mode With 2-Channel Output	10
Sub Out—Using Multiple Abysss	11
AC Power Connection	12
Replacing the Fuse	
Break-In	
Placement	13
Listening Position	
Ask Your Dealer	
Enjoy Yourself	
Installing Abyss in a Cabinet	14

Room Acoustics	15
Your Room	
Terminology	
Solid Footing	16
Home Theater	17
Frequently Asked Questions & Troubleshooting	18
General Information	19
Specifications	
Warranty and Registration	
Service	
Glossary of Audio Terms	20
Notes	22



In accordance with the European Union WEEE (Waste Electrical and Electronic Equipment) directive effective August 13, 2005, we would like to notify you that this product may contain regulated materials which upon disposal, according to the WEEE directive, require special reuse and recycling processing.

For this reason MartinLogan has arranged with our distributors in European Union member nations to collect and recycle this product at no cost to you. To find your local distributor please contact the dealer from whom you purchased this product, email info@martinlogan.com or visit the distributor locator at www.martinlogan.com.

Please note, only this product itself falls under the WEEE directive. When disposing of packaging and other related shipping materials we encourage you to recycle these items through the normal channels.

INSTALLATION IN BRIEF

We know that you are eager to hear your new Abyss subwoofer, so this section is provided to allow fast and easy set up. Once you have it operational, please take the time to read, in depth, the rest of the information in this manual. It will give you perspective on how to attain the greatest possible performance from this most exacting woofer system.

If you experience any difficulties in setup or operation of the Abyss, please refer to the Placement, Room Acoustics and Connections and Control Settings sections.

Should you encounter a persistent problem that cannot be resolved, please contact your authorized MartinLogan dealer. They will provide you with the appropriate technical analysis to alleviate the situation.



WARNING!

- Hazardous voltages exist inside—do not remove cover.
- Refer servicing to a qualified technician.
- To prevent fire or shock hazard, do not expose this module to moisture.
- Unplug subwoofer should any abnormal conditions occur.
- Use only with a grounded outlet.



The lightning bolt flash with arrowhead symbol within an equilateral triangle is intended to alert the user to the presence of uninsulated “dangerous voltage” within the product’s enclosure that may be of sufficient magnitude to constitute a risk of electric shock.



The exclamation point within an equilateral triangle is intended to alert the user to the presence of important operating and maintenance (servicing) instructions in the literature accompanying the appliance.

Step 1: Unpacking

Remove your new Abyss subwoofer from its packing.

Step 2: Placement

Ideally, place the Abyss in a corner near the front of the room. This is a good place to start. Please see the Placement section (page 13) of this manual for more details.

Step 3: Signal Connection

Use the best cables you can. High quality cables, available from your specialty dealer, are recommended and will give you superior performance.

Attach your preamplifier/processor outputs through cables to the signal input area located on the Abyss’s rear panel. Please see the Connections and Control Settings section (pages 6–12) of this manual for more details.

If you plan to connect your Abyss using speaker level (high level) inputs, please refer to the 2-Channel Mode Using Speaker Level Inputs section (page 9) of this manual for more details.

Please note, when Abyss is set up in a down-firing configuration the grill cover can be used to cover the connections and controls. The grill cover features a channel (on its bottom side) through which cables can pass.

Step 4: Power Connection (AC) (see warning)

Make sure the level knob is set at 0. Plug the Abyss subwoofer into a wall outlet. Review the AC Power Connection section (page 12) of this manual for more details.

Step 5: Setting the Controls

Set the level knob to a medium volume position (12 o’clock). Set the power switch to ‘Auto’.

Step 6: Listen and Enjoy

Now, you may adjust your system and enjoy!

INTRODUCTION

Congratulations! You have invested in one of the world's premier subwoofers.

The MartinLogan Abyss represents the extension of an intensive, dedicated team research program directed toward establishing a world class line of reference subwoofers using leading-edge technology, without compromising durability, reliability, craftsmanship or aesthetics.

The Abyss subwoofer uses a 10-inch high-excursion aluminum element driver to achieve deep, tight, well-defined bass. A proprietary amplifier is used to drive the output stage with precision and extremely high efficiency. Low-pass filtering and phase control have been designed to make integrating the Abyss subwoofer with MartinLogan and non-MartinLogan products both seamless and simple.

The materials in your new Abyss subwoofer are of the highest quality and will provide years of enduring enjoyment and deepening respect. The cabinetry is constructed from the finest composite material for acoustical integrity and is finished with an attractive custom coating.

This User's Manual will explain in detail the operation of your Abyss subwoofer and the philosophy applied to its design. A clear understanding will insure that you obtain maximum performance and pleasure from this most exacting subwoofer.

ABOUT THE CONTROLS

Level Knob

Setting the level too high will cause the bass to seem bloated and is the single most common cause of bad sounding subwoofers. A rule of thumb is that the subwoofer should not draw attention to itself, but should simply make the systems low end seem more extended and accurate.

Low Pass Filter Knob

When the Abyss is connected in multi-channel mode (via its LFE input), the low pass filter is not active and your processor handles the bass management. When connected in 2-channel mode (via its speaker or line level left/right input), the low-pass filter is active.

As a general rule the low pass filter should be set at the option approximately equal to 70% of your speaker's lowest frequency response. Example: The MartinLogan Aeon i's lowest frequency response is 43Hz. 70% of 43Hz equals 30.1, so you should set the Abyss's low pass filter to 30Hz. Remember, this is a general rule. We advise that once you try the recommended setting using the formula above, you should try the surrounding settings to see which sounds best.

Phase Control Switch

The phase control is entirely dependent on the size and configuration of your listening environment, the placement of the unit, and your seating arrangement. Due to the way bass sound waves develop in different rooms, there is no rule of thumb for setting phase. For instance, if your room has a peak at the subwoofer crossover area, you may wish to set the phase so the actual acoustic outputs of the subwoofer and main speakers are out of phase. Experiment, try different settings and be patient.

Auto/On/Standby Power Switch

The Auto/On/Standby switch controls Abyss's energy saving feature. When set to 'Auto', the Abyss will turn on when a music signal is detected and off when there is none. The 'On' setting prevents the Abyss from entering energy saving mode. The 'Standby' setting forces the Abyss into energy saving mode. While set to 'Standby', the Abyss will not perform.

Status Light

The Abyss is equipped with a multi-color LED to indicate the subwoofers current status. The following list explains the meaning of the different colors:

No color: No power. The Abyss is not plugged in.

Red: Energy saving mode and safety mode. If the power switch is set to 'Auto' this indicates the Abyss detects no audio signal and has automatically switched into energy saving mode. Setting the power switch to 'Standby' will force the Abyss into this mode. This also indicates if the Abyss's temperature has exceeded nominal operating range. The Abyss will resume normal play mode when the temperature-sensor reports a safe operating temperature.

Green: Play mode. If the power switch is set to 'Auto' this indicates the Abyss detects an audio signal and has automatically switched into play mode. Setting the power switch to 'On' will force the Abyss into this mode.

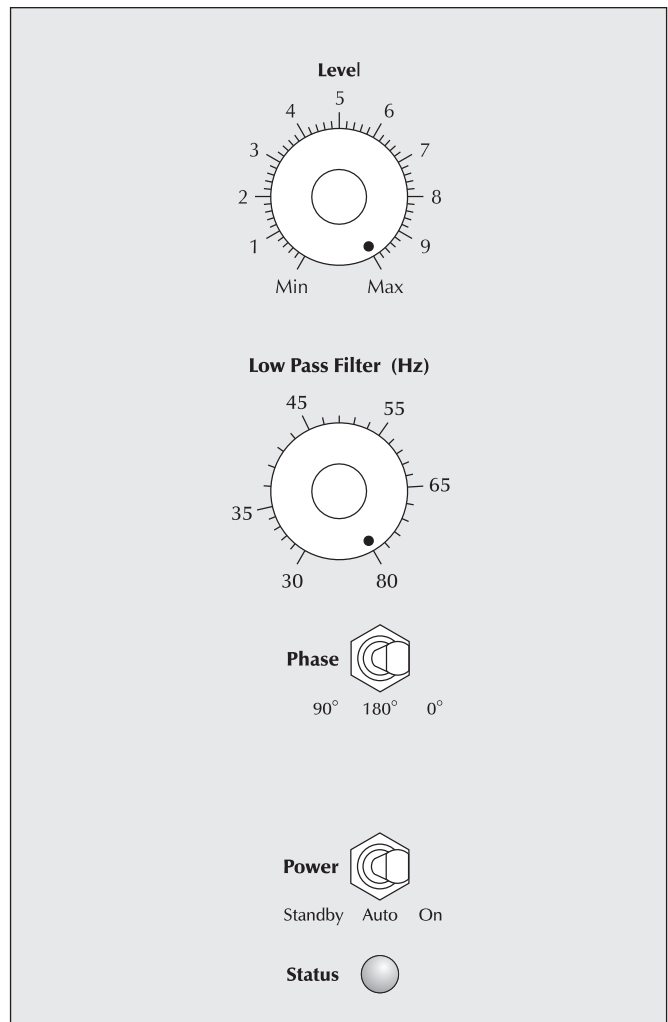

Figure 1. Abyss controls.

CONNECTIONS AND CONTROL SETTINGS

Before Connecting the Abyss

MartinLogan's engineering and design team developed the Abyss for easy setup and system integration. Before beginning to connect your Abyss, please review the controls discussed in the last section. An understanding of these will help speed you along as you connect and integrate your Abyss with your system. All signal connections are done at the signal input section on the rear connections panel of the Abyss. Make certain that all of your connections are tight.



WARNING! Turn your Abyss subwoofer to standby before making or breaking any signal connections!

2-Channel Mode

This setup is recommended if your Abyss will be used in a 2-channel system with main speakers playing full range. When a signal is connected to the Abyss's left/right inputs, the Abyss's internal low pass filter is active.

Signal Connection (see figure 2):

- 1 Connect the left and right outputs of your preamplifier to the left and right inputs of the Abyss using quality RCA interconnects. If your preamplifier only has one set of outputs you may need to obtain Y adapters from your dealer.

Recommended Control Settings (see figure 3):

- 1 Set the low-pass filter switch to the closest option equal to 70% of your loudspeakers lowest frequency response.
- 2 While playing music with bass content, turn the level control up until the music has deep extended bass, being careful to avoid levels that become overwhelming.
- 3 Try the phase control in different settings until the best blending is obtained. If you are using the Abyss to augment other MartinLogan products, we suggest you start with the phase set at 90°.

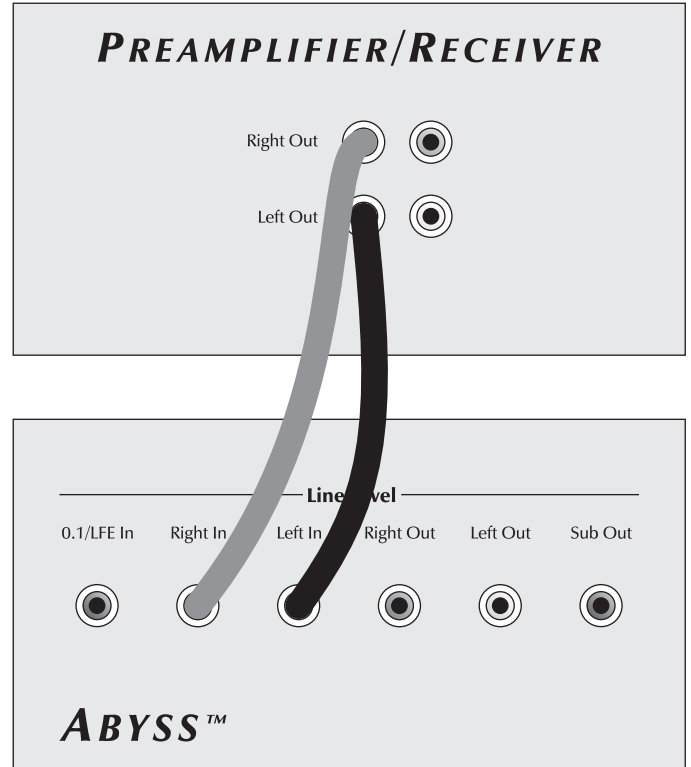

Figure 2. Signal connection for 2-channel mode.

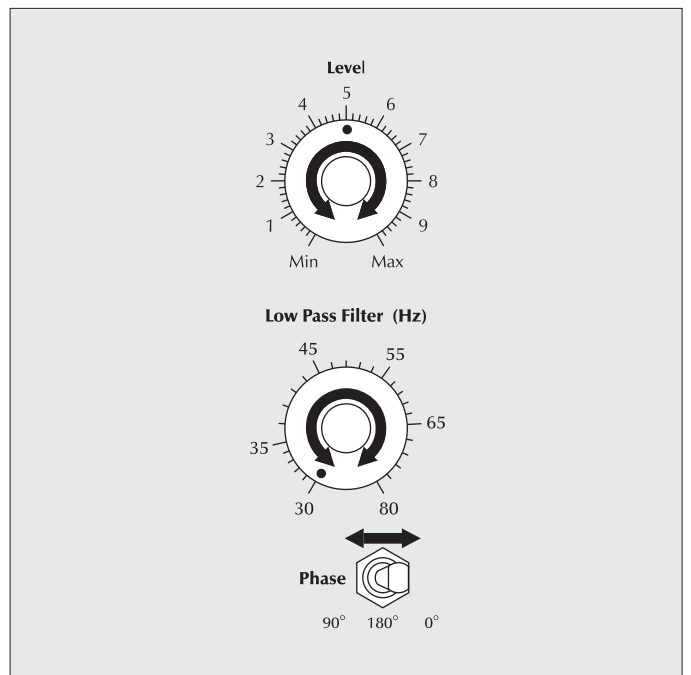

Figure 3. Control settings for 2-channel mode.

Multi-Channel Mode

This setup is recommended if your Abyss will be used in a dedicated home theater or multi-channel system. When a signal is connected to the Abyss's LFE input, Abyss's internal low pass filter is not active. By following this setup, you will allow your processor to handle most of the bass management.

Signal Connection (see figure 4):

- 1 Connect the LFE/0.1 subwoofer output of the processor to the LFE input of the Abyss using a quality RCA interconnect.



WARNING!

Based on the performance of most processors, it is recommended that MartinLogan center and effects type speakers (i.e. Cinema i, Theater i and Script i) not be run in large, wide or full range mode. Doing so may potentially damage the speaker if the processor attempts to drive the speaker beyond its rated frequency range. This warning also applies to products from other manufacturers.

It is recommended to run center and effects type speakers in limited or narrow mode.

Some processors have an option to route the 0.1 channel to your main and/or surround speakers. We recommend that you do not use this option.

Recommended Control Settings (see figure 5):

- 1 Use the bass management section of your processor's speaker level setup option to set the subwoofer level at an appropriate level. Follow the instructions in your processor manual to fine-tune the subwoofer level.
- 2 If your processor offers the option to setup crossovers for a subwoofer, we recommend that you start with the following settings—Crossover: 70Hz, High-Pass: 12dB, and Low-Pass: 24dB. The optimal setting for these options may vary depending on your room and listening preferences.
- 3 Adjust the phase control until ideal blending is obtained. If you hear no discernible difference leave the phase at 0°.
- 4 Follow the instructions in your processor manual to fine-tune the subwoofer level.

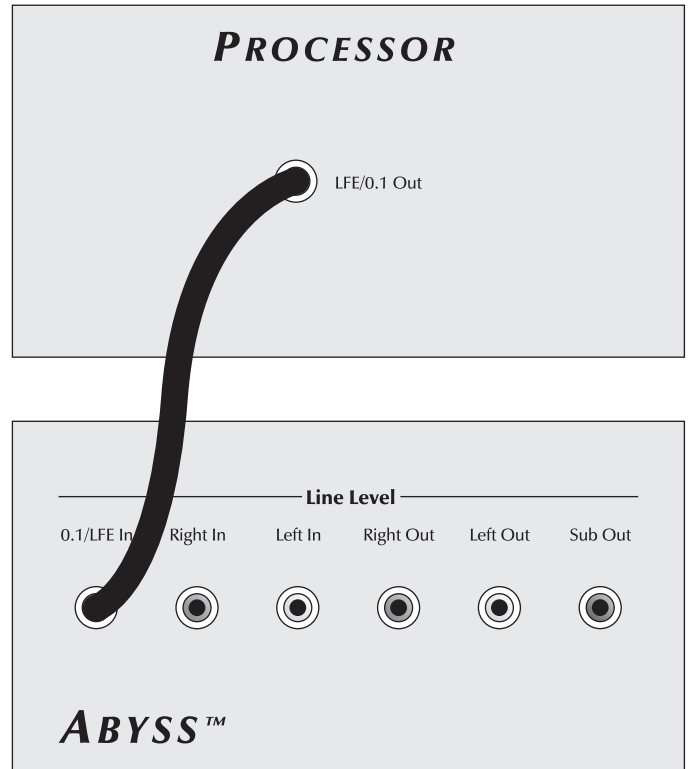

Figure 4. Signal connection for multi-channel mode.

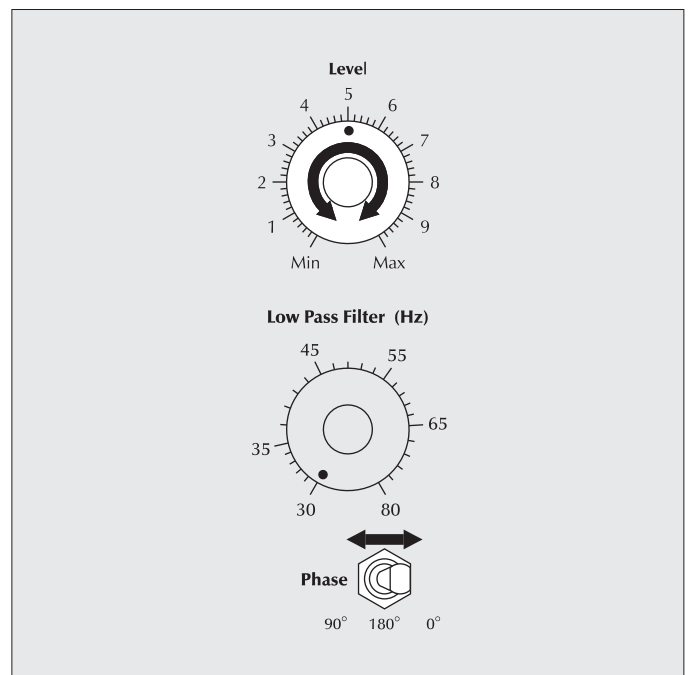

Figure 5. Control settings for multi-channel mode.

2-Channel/Multi-Channel Mode

Using an A/V processor and the Abyss's low pass filters.

This setup is recommended if your Abyss will be used in both 2-channel mode and as a LFE (0.1) channel in a multi-channel mode. By following this setup, you will allow your processor to handle most of the bass management while running in multi-channel mode, and relinquish control of the low pass filter to the Abyss when running in a 2-channel mode.

Signal Connection (see figure 6):

- 1 Connect the left and right outputs of your preamplifier to the left and right inputs of the Abyss using quality RCA interconnects. If your preamplifier only has one set of outputs you need to obtain Y adapters from your dealer.
- 2 Connect the LFE/0.1 output of the processor to the LFE input of the subwoofer using quality RCA interconnects.

Recommended Control Settings (see figure 7):

- 1 Set your front speakers for wide, large or full mode in your processor. Set the center and effects type speakers in limited or narrow mode (see the warning on page 7).
- 2 Set the low-pass filter switch to the closest option equal to 70% of your loudspeakers lowest frequency response.
- 3 While playing music with bass content, turn the level control up until the music has deep bass that is not overwhelming.
- 4 Try the phase control in different settings until the best blending is obtained. If you are augmenting MartinLogan loudspeakers, we suggest you start with the phase set at 90°.
- 5 Use the bass management section of your processor's speaker level setup option to set the subwoofer level at an appropriate level. Follow the instructions in your processor's manual to fine-tune the subwoofer level.
- 6 If your processor offers the option to setup crossovers for a subwoofer, we recommend that you start with the following settings—Crossover: 70Hz, High-Pass: 12dB, and Low-Pass: 24dB. The optimal setting for these options may vary depending on your room and listening preferences.

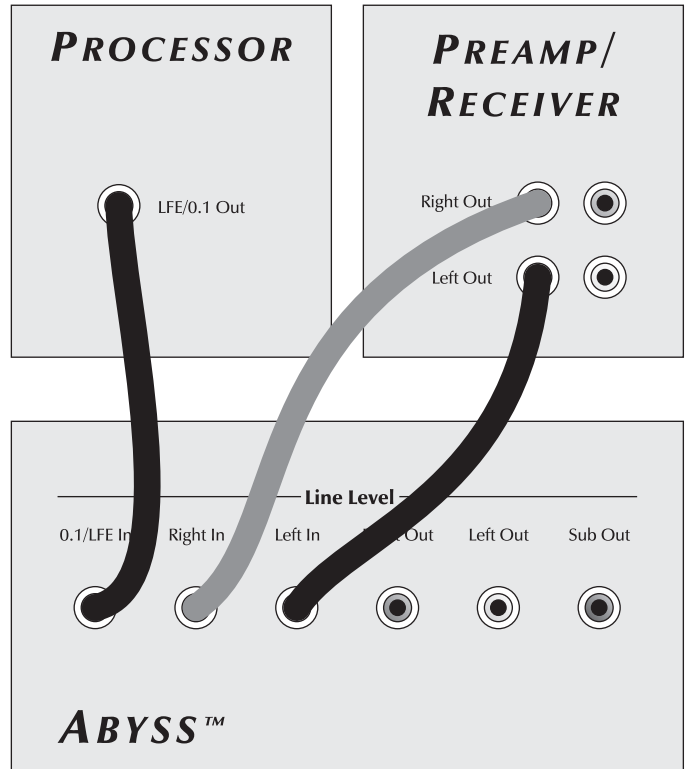

Figure 6. Signal connection for 2-channel/multi-channel mode.

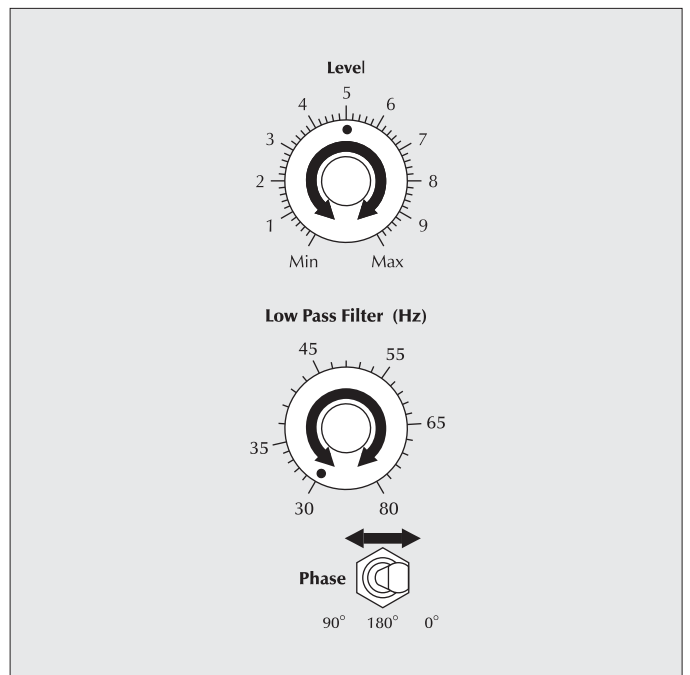

Figure 7. Control Settings for 2-channel/multi-channel mode.

2-Channel Mode Using Speaker Level Inputs

This setup is recommended if your Abyss will be used in a 2-channel only system with full-range front loudspeakers. When a signal is connected to the Abyss's Left/Right Inputs, the Abyss's internal low pass filter is active.

Signal Connection (see figure 8):

- 1 Connect the left and right outputs of your amplifier to the left and right speaker level (high level) inputs of the Abyss using quality speaker cable.

If your amplifier only has one set of outputs you may connect your amplifier to your speakers as normal and run an additional set of cables from your speakers to the Abyss's left and right speaker level (high level) inputs.

It is also possible to connect the left and right outputs of your amplifier to the left and right speaker level (high level) inputs of the Abyss and run an additional set of cables from your Abyss to the speakers.

Recommended Control Settings (see figure 9):

- 1 Set the low-pass filter switch to the closest option equal to 70% of your loudspeakers lowest frequency response.
- 2 While playing music with bass content, turn the level control up until the music has deep extended bass, being careful to avoid levels that become overwhelming.
- 3 Try the phase control in different settings until the best blending is obtained. If you are using the Abyss to augment other MartinLogan products, we suggest you start with the phase set at 90°.

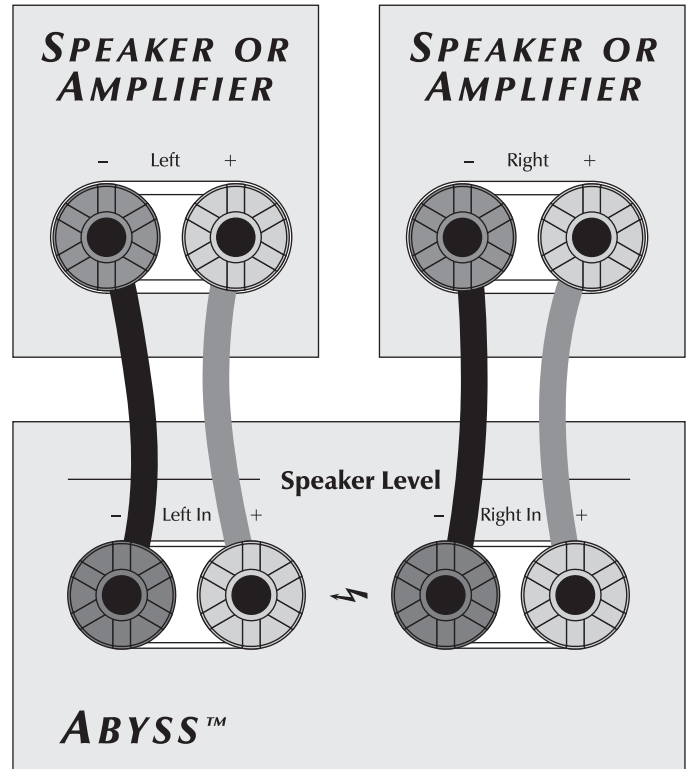

Figure 8. Signal connection for 2-channel mode using speaker level inputs.

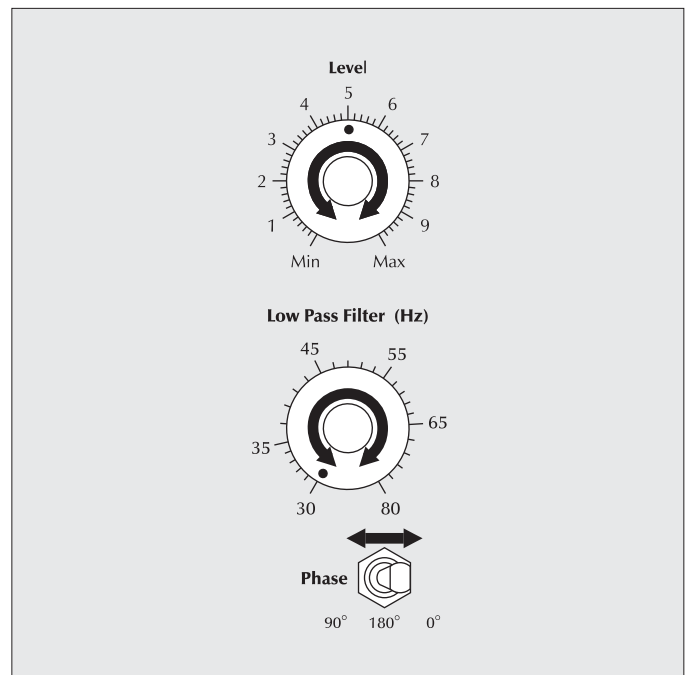

Figure 9. Control settings for 2-channel mode using speaker level inputs.

2-Channel Mode With 2-Channel Output

This setup is recommended if your Abyss will be used in a 2-channel only system.

Signal Connection (see figure 10):

- 1 Connect the left and right outputs of your preamplifier to the left and right inputs of the Abyss using quality RCA interconnects.
- 2 Connect the left and right outputs of your Abyss to the left and right inputs of your amplifier using quality RCA interconnects.

Recommended Control Settings (see figure 3):

- 1 Set the controls as recommended on page 6.

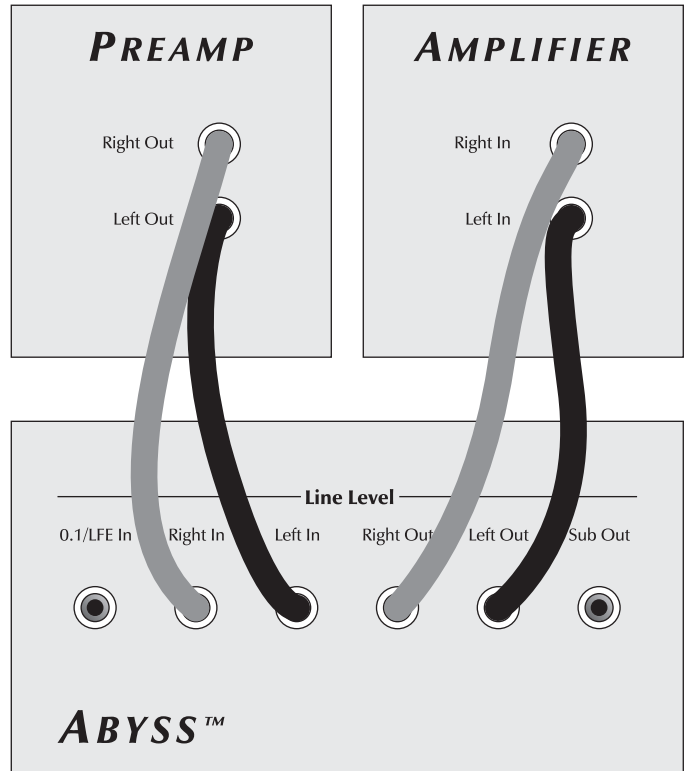

Figure 10. Signal connection for 2-channel mode with 2-channel output.

Sub Out—Using Multiple Abyss'

Using Sub Out offers an easy way to implement multiple Abyss' in your audio/video system.

Note: All additional Abyss subwoofers must run as either dedicated 2-channel (stereo) or multi-channel (LFE) subwoofers, but not both.

Signal Connection:

- 1 Connect the first Abyss to your system using one of the five modes previously described.
- 2 Connect the Sub Out of the previous Abyss to either the LFE or the Right (or Left) input of the next Abyss using a quality RCA interconnect. Connecting to the LFE input allows additional subwoofers to perform as dedicated LFE channels (see figure 11). Connecting to the Right (or Left) input allows additional subwoofers to perform as dedicated 2-channel subwoofers (see figure 12).
- 3 Repeat step 2 for each additional Abyss subwoofer in the chain using the same input for every connection.

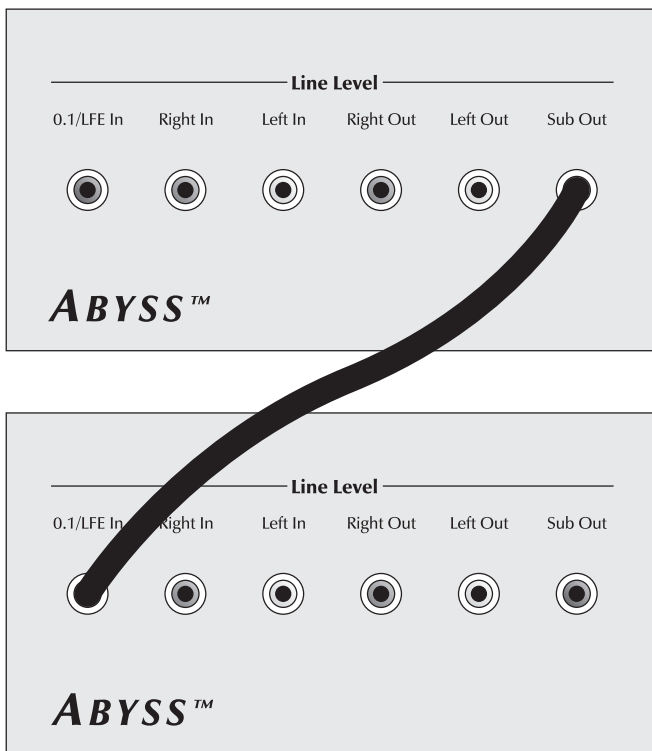

Figure 11. Signal connection for using multiple Abyss for LFE.

Recommended Control Settings:

- 1 Adjust the control settings of the first subwoofer using the recommended control settings from the connection method used to connect the master Abyss with your audio system.
- 2 Adjust the control settings of each additional subwoofer using the recommended control settings from the connection method used to connect the master Abyss with your audio system.

Note: While the settings of each subwoofer should be similar, you will probably find that each sub will need to be tweaked for optimal performance because of its unique room placement.

Regardless of how you use your subwoofer, experimentation can often result in better sound. Don't be afraid to try different settings. You can always return the controls to their previous locations.

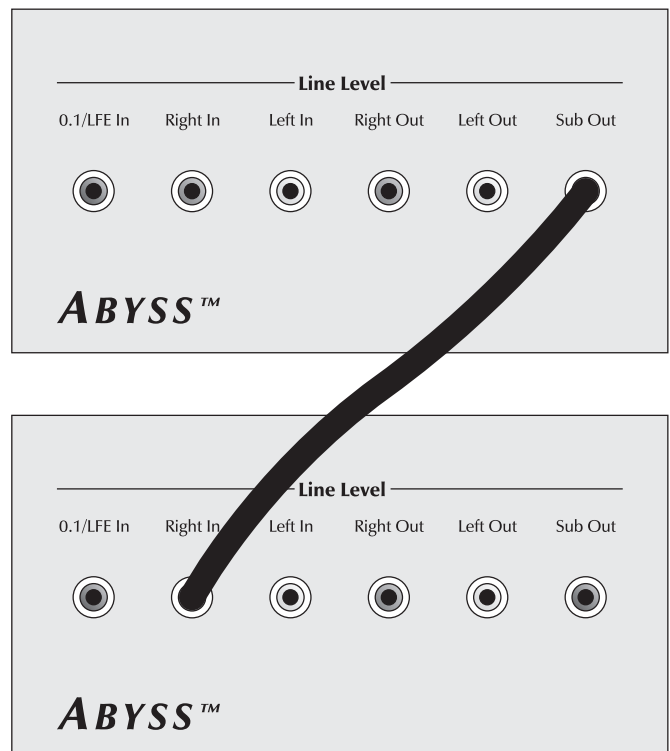

Figure 12. Signal connection for using multiple Abyss for stereo.

AC Power Connection



WARNING! The power cord should not be installed, removed, or left detached from the subwoofer while the other end is connected to an AC power source.

The IEC power cord should be firmly inserted into the AC power receptacle on the rear connection panel of the Abyss, then to any convenient AC wall outlet. The Abyss also integrates a signal sensing power supply that automatically switches off after sensing no music signal for several minutes (this will occur when the power switch is set to 'Auto').

Your Abyss subwoofer is wired for the power service supplied in the country of original consumer sale. The AC power rating applicable to a particular unit is specified both on the packing carton and on the serial number plate attached to the subwoofer.

If you remove your Abyss subwoofer from the country of original sale, be certain that AC power supplied in any subsequent location is suitable before connecting and operating the subwoofer. Substantially impaired performance or severe damage may occur to the Abyss subwoofer if operation is attempted from an incorrect AC power source.

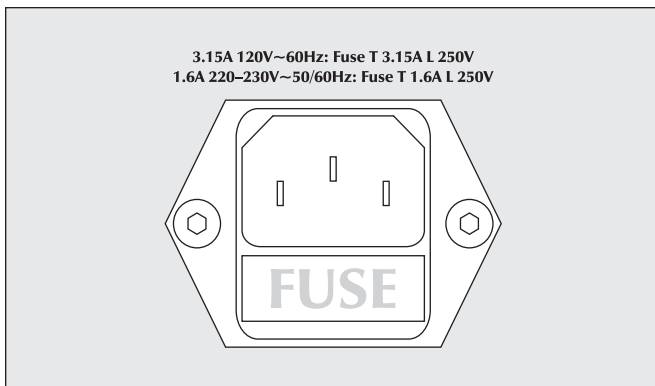

Figure 13. IEC power cord AC receptacle and fuse.

Replacing the Fuse

If the fuse in your Abyss should require changing, turn off and unplug your Abyss before removing the fuse. Replace the bad fuse with a matching T 3.15A L 250V (T 1.6A L 250V if you are in a region using 220v–230v current).

Break-In

Our custom made woofers require approximately 50 hours of break-in at moderate listening levels before their optimal performance occurs. This will factor in on any critical listening and judgment.

Listening Position

Generally, subwoofers have the most output when placed in the corner of a room. However, this can also exaggerate the subwoofers output making blending difficult. We recommend starting by placing the Abyss in a corner. If, after the full range of tuning techniques have been employed, the subwoofer sounds like it has too much upper bass energy try pulling it away from the wall, toward the listening position. This will lessen the reinforcement of these problematic frequencies from the wall and likely smooth out the response. Repeat the tuning techniques with the woofer controls after you move it (see figure 14).

Ask Your Dealer

Your MartinLogan dealer can suggest many options for optimal subwoofer placement. They also have many tools at their disposal, such as experience, familiarity with the associated equipment and even sound analysis equipment which may make the task of determining optimal subwoofer placement easier.

Enjoy Yourself

The Abyss is a very refined subwoofer and will benefit from care in setup. With the above placement tips in mind you will find, over months of listening, that small changes can result in measurable differences. As you live with your subwoofer, do not be afraid to experiment with positioning until you find the optimal relationship between your room, settings and subwoofer that gives you the best results. Your efforts will be rewarded.

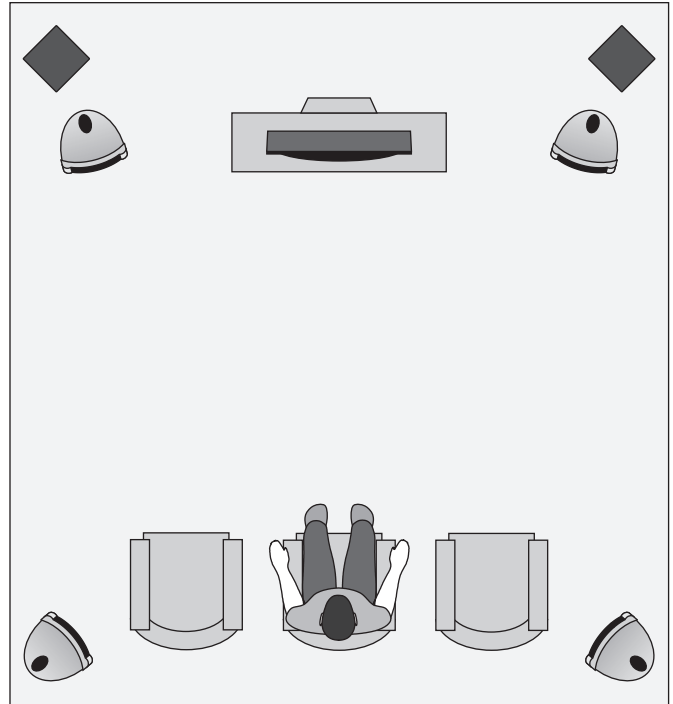

Figure 14. Abyss Subwoofers as the LFE (effects) channels, MartinLogan Clarity™ speakers as front and surround (effects) channels, MartinLogan Fresco™ as the center channel. Note the corner placement of the Abyss at the front of the listening room.

Installing Abyss in a Cabinet

When placing the Abyss inside of a cabinet it is recommended that there be a minimum of three inches of open space between the cabinet and the front and back sides (see figure 15).

When installing the Abyss in a cabinet it is recommended that the subwoofer be converted to a front firing configuration. *Please note, when the Abyss is in a front firing configuration 90° RCA adaptors may be required to make signal connections. Two 90° RCA adaptors are included with the Abyss subwoofer.*

Converting Abyss to Front Firing Configuration:

- 1 Prepare a flat surface with a blanket to protect the Abyss' finish. Unplug signal and power connections. Turn the Abyss upside down. Gently lift and remove the Abyss base (see figure 16).
- 2 Rotate the cabinet 90°, positioning the backplate on top (see figure 17).
- 3 Place the Abyss base over the backplate and gently push it into place. Install the grill cover onto the front of the Abyss (see figure 18). *Please note, when the Abyss is used in a down firing configuration 90° RCA adaptors may be required to make signal connections. Two 90° RCA adaptors are included with the Abyss subwoofer.*

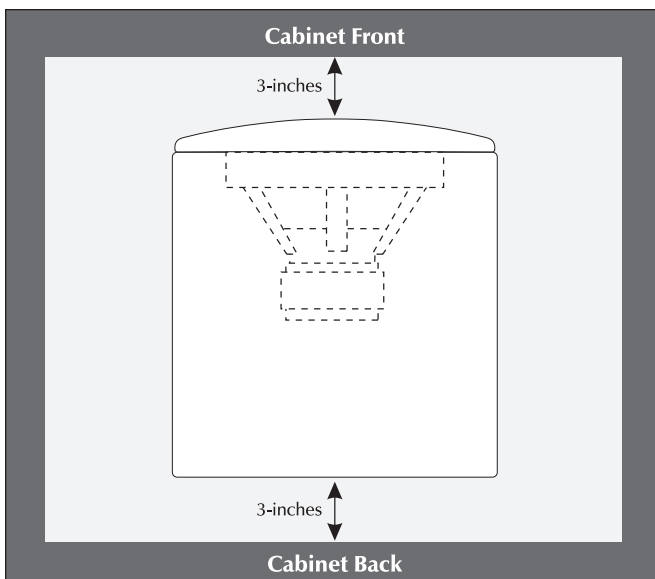

Figure 15. Placing the Abyss in a cabinet requires a minimum of three inches of open space on the front and back.

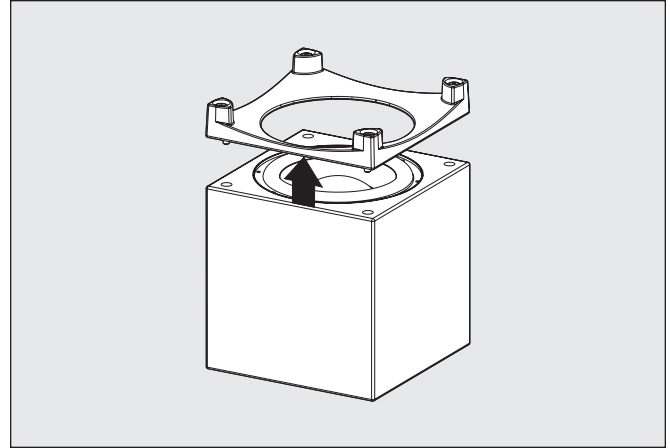

Figure 16. Step 1—Converting the Abyss to a front firing configuration.

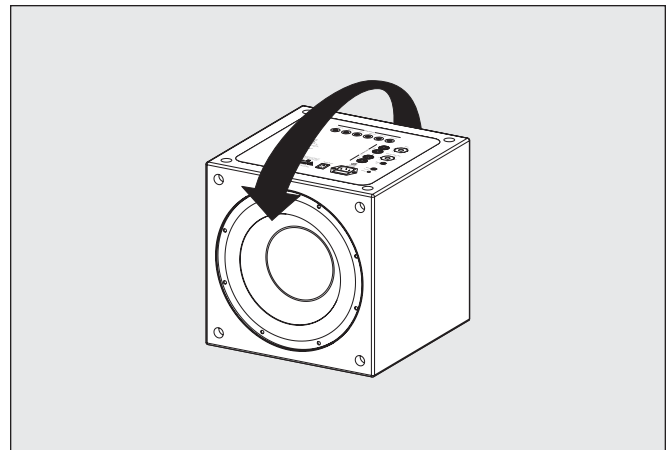

Figure 17. Step 2—Converting the Abyss to a front firing configuration.

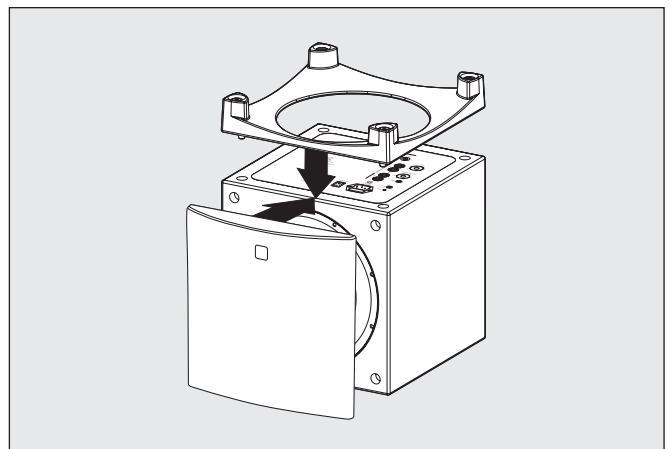

Figure 18. Step 3—Converting the Abyss to a front firing configuration.

Your Room

This is an area that requires both a little background to understand and some time and experimentation to attain the best performance from your system.

Your room is actually a component and an important part of your system. This component is a large variable and can dramatically add to or subtract from a great sonic experience.

All sound is composed of waves. Each frequency has its own wave size, with the lower, or bass frequencies literally encompassing from 10 feet to as much as 40 feet. Your room participates in this wave experience like a swimming pool with waves reflecting and becoming enhanced depending on the size and shape of the room and the types of surfaces in the room.

Remember that your audio system can actually generate all of the information required to recreate a sonic event in time, space, and tonal balance. Acoustically, the role of an ideal room would be to neither delete nor contribute to that information. However, nearly every room does to some degree.

Terminology

Standing Waves

Sound coming from a speaker bounces around in a room until a pattern emerges—this is called a standing wave. Typically, this is only a problem with frequencies below 100Hz. When this happens different parts of your room experience either an excess or a lack of bass.

Some people believe that having a room without parallel walls will eliminate this effect. The truth is that non-parallel walls only generate different standing wave patterns than those that occur in rectangular rooms.

Usually, you can excite most of the standing waves in a room by putting the Abyss in a corner. Listening position determines which standing waves you will experience. For instance, if you sit in a corner you will hear most of the standing waves. This can be an overpowering experience. Sitting next to a wall can also intensify the levels of the standing waves that are experienced.

Resonant Surfaces and Objects

All of the surfaces and objects in your room are subject to the frequencies generated by your system. Much like an instrument, they will vibrate and "carry on" in syncopation with the music, and may contribute in a negative way to the sound. Ringing, boominess, and even brightness can occur simply because surfaces and objects are "singing along" with your speakers.

Resonant Cavities

Small alcoves or closet type areas in your room can be chambers that create their own "standing waves" and can drum their own "one note" sounds.

Solid Footing

After living and experimenting with your Abyss, you may want to use Mini ETC™ (Energy Transfer Coupler) Spikes (see figure 19), available from the Xtatic shop at www.martinlogan.com. With the use of these spikes, the Abyss will become more firmly planted on the floor and, consequently, bass will tighten. It is best not to implement the spikes, however, until you are secure in the positioning, as the spikes can damage the floor if the subwoofer is moved. MartinLogan Mini ETC spikes will fit any common 1/4-inch thread insert that may be found on your other audio equipment (racks, speakers, etc).

Spike Installation Instructions:

- 1 Carefully lay the Abyss on its side to gain access to the bottom.
- 2 Remove existing feet or spikes. Thread new spikes into holes and screw them in all of the way.
- 3 Tighten jam nut snugly by hand. Do not over tighten the nut.
- 4 Right the subwoofer.

Caution: Make sure your hands and any cabling are clear of the spikes. Do not slide the subwoofer as spikes are sharp and can damage your floor or carpet.

- 5 Adjust to level by rotating spikes. Tighten the jam nut securely when satisfied that the subwoofer is level.

Caution: Walking the Abyss may result in a broken spike.

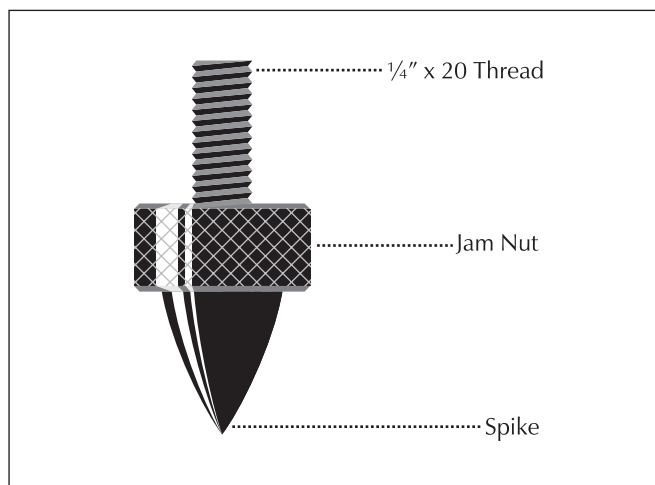

Figure 19. The Mini ETC Spike.

It had long been the practice of stereo buffs to connect their television to the stereo system. The advantage was the use of the larger speakers and more powerful amplifier of the stereo system. Even though the sound was greatly improved, it was still mono and limited by the broadcast signal.

In the late 1970's and early '80's two new home movie formats became widely available to the public: VCR and laser disc. At the same time video screen sizes began increasing.

By 1985, both formats had developed into very high quality audio/video sources. In fact, the sonic performance of some video formats exceeded audio-only formats. Now, with theater quality sound available at home, the only element missing was the "surround sound" presentation found in movie houses.

Fortunately, "Dolby" and "DTS" encoded material (which include almost all movies) have the same surround sound information encoded on home releases as the theater films. All that is required to retrieve this information is a decoder, additional speakers, subwoofer(s) and amps to reproduce it.

Home theater is a complex purchase and we recommend that you consult your local MartinLogan dealer, who is well versed in this subject.

Each piece of a surround system can be purchased separately. Take your time and buy quality. No one has ever complained that the movie was too real. The following list and descriptions will only give you a brief outline of the responsibilities and demands placed on each speaker.

Front Left and Front Right

If these speakers will also be the same two used for your stereo playback then they should be of very high quality and able to play loud (over 102 dB) and reproduce bass below 80 Hz.

Center Channel

Many experts believe this to be the most important speaker in a home theater system, as almost all of the dialogue and a large portion of the front speaker information is reproduced by the center channel. It is important that the same manufacturer of the front speakers design the center speaker and that it is recommended for use as a center speaker. This is not the place to cut corners.

Surround Speakers

We recommend that the surround speakers play down to 70hz. The surround, or effect speakers contain critical information. In films, sound effects are vital to the director in delivering a complete experience and the rapid technical increase in the discreet capacity of these effects channels has made their quality vital. This is equally true in music play back because of the emerging high definition, multi-channel music only formats. Full range instruments, voices and ambient queues are being routed to the effects channel. In the past, some may have suggested that this was the place to save money by purchasing small inexpensive speakers. If you choose to do so, be prepared to upgrade in the future.

Subwoofer

With any good surround system you will need one or more high quality subwoofers (the .1, in a 5.1 channel surround system). Most movie soundtracks contain large amounts of bass information as part of the special effects. Good subwoofers will provide a foundation for the rest of the system.

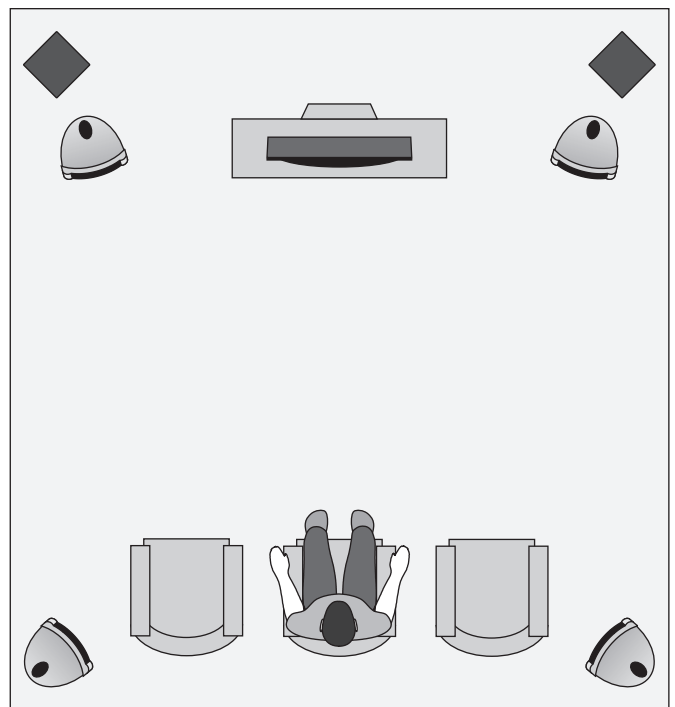

Figure 20 Abyss Subwoofers as the LFE (effects) channels, MartinLogan Clarity speakers as front and surround (effects) channels, MartinLogan Fresco as the center channel.

FREQUENTLY ASKED QUESTIONS & TROUBLESHOOTING

Frequently Asked Questions

How do I clean my subwoofer?

Use a dust free cloth or a soft brush to clean your subwoofer. We recommend a specialty cloth (available through the Xstatic shop at www.martinlogan.com) that cleans better than anything else we have tried.

Is it safe to set things on my subwoofer?

While your Abyss is designed with a durable, stain-resistant surface, we advise you not to set anything on your Abyss—especially containers holding liquids.

Is there likely to be any interaction between my subwoofer and the television in my Audio/ Video system?

Yes. The Abyss subwoofer doesn't use a shielded driver. We recommend 3 feet between the Abyss subwoofer and video components that are susceptible to magnetic fields.

Will my electric bill go 'sky high' by leaving my subwoofer plugged in all the time?

No. The Abyss, when the power switch is set to 'Auto' or 'Standby', will draw about 13 watts when idle.

Should I unplug my subwoofer during a thunderstorm?

Yes, or before. It's a good idea to disconnect all of your audio/video components during stormy weather.

Troubleshooting

No Output

- Check that all your system components are turned on.
- Check that the master power switch adjacent to the AC receptacle is set to 'On'.
- Check that the power switch on the Abyss is set to either 'Auto' or 'On'.
- Check your wires and connections.
- Check all interconnecting cables.
- Make sure the level control is not turned down.
- Turn off and unplug the Abyss and check the fuse near the AC power cord receptacle on the back. If the fuse has blown, replace the bad fuse with a matching T 3.15A L 250V fuse (T 1.6A L 250V if you are in a region using 220v–230v current).
- If the problem persists, contact your dealer.

Muddy Bass

- Check placement. Try moving the subwoofer closer to the front and side walls.
- Check the type of feet that are being used. Try installing the Mini ETC spikes.
- Decrease the level.
- Check your processor setup.
- If the problem persists, contact your dealer.

Hums or Unusual Sounds

- Turn the Abyss off, unplug all signal inputs, turn the Abyss back on and turn up the level. If the problem disappears, the hum is originating elsewhere in your system.
- Connect the Abyss's AC connection to the same AC circuit as the pre amp.
- If the problem persists, contact your dealer.

Specifications

The high-resolution Abyss subwoofer system consists of a single woofer for high SPL output with minimal distortion. The equalization used is specifically designed to counteract the response of the woofers sealed box response. This equalization leads to minimal group delay and proper transient response.

System Frequency Response

23–120 Hz \pm 3 dB. Anechoic through the LFE effects input.

Low Pass Filter Frequencies

30Hz–80Hz

High Pass Filter Frequency

70Hz

Phase

0°, 90°, 180°

Components

12" (30.5cm) high-excursion, aluminum cone with extended throw driver assembly

Amplifier

300 watts RMS

Impedance

L&R RCA – 20,000 Ohms

LFE RCA – 34,000 Ohms

Inputs

Left/Right RCA Line Level, RCA LFE, Speaker Level

Output

Left/Right RCA Line Level, RCA Sub Out

Weight

40 lbs. each (18.1 kg)

Size

13.5" inches W x 15.2" inches D x 15.8" inches H
(34.4cm W x 38.6cm D x 40.1cm H)

Warranty and Registration

Your Abyss subwoofer is provided with an automatic Limited 90 Day Warranty coverage.

You have the option, at no additional charge, to receive Limited 3-Year Warranty coverage. To obtain the Limited 3-Year Warranty coverage you need to complete and return the Certificate of Registration, included with your subwoofer, and provide a copy of your dealer receipt, to MartinLogan within 30 days of purchase.

For your convenience MartinLogan also offers online warranty registration at www.martinlogan.com.

MartinLogan may not honor warranty service claims unless we have a completed Warranty Registration card on file!

If you did not receive a Certificate of Registration with your new Abyss subwoofer you cannot be assured of having received a new unit. If this is the case, please contact your authorized MartinLogan dealer.

Service

Should you be using your MartinLogan product in a country other than the one in which it was originally purchased, we ask that you note the following:

- 1 The appointed MartinLogan distributor for any given country is responsible for warranty servicing only on units distributed by or through it in that country in accordance with its applicable warranty.
- 2 Should a MartinLogan product require servicing in a country other than the one in which it was originally purchased, the end user may seek to have repairs performed by the nearest MartinLogan distributor, subject to that distributor's local servicing policies, but all cost of repairs (parts, labor, transportation) must be born by the owner of the MartinLogan product.
- 3 If, after owning your subwoofer for six months, you relocate to a country other than the one in which you purchased your subwoofer, your warranty may be transferable. Contact MartinLogan for details.

GLOSSARY OF AUDIO TERMS

AC. Abbreviation for alternating current.

Active crossover. Uses active devices (transistors, ICs, tubes) and some form of power supply to operate.

Amplitude. The extreme range of a signal. Usually measured from the average to the extreme.

Arc. The visible sparks generated by an electrical discharge.

ATF. The abbreviation for advanced thin film.

Bass. The lowest frequencies of sound.

Bi-Amplification. Uses an electronic crossover, or line-level passive crossover, and separate power amplifiers for the high and low frequency loudspeaker drivers.

Capacitance. That property of a capacitor which determines how much charge can be stored in it for a given potential difference between its terminals, measured in farads, by the ratio of the charge stored to the potential difference.

Capacitor. A device consisting of two or more conducting plates separated from one another by an insulating material and used for storing an electrical charge. Sometimes called a condenser.

Clipping. Distortion of a signal by its being chopped off. An overload problem caused by pushing an amplifier beyond its capabilities. The flat-topped signal has high levels of harmonic distortion which creates heat in a loudspeaker and is the major cause of loudspeaker component failure.

CLS. The abbreviation for curvilinear linesource.

Crossover. An electrical circuit that divides a full bandwidth signal into the desired frequency bands for the loudspeaker components.

dB (decibel). A numerical expression of the relative loudness of a sound. The difference in decibels between two sounds is ten times the Base 10 logarithm of the ratio of their power levels.

DC. Abbreviation for direct current.

Diffraction. The breaking up of a sound wave caused by some type of mechanical interference such as a cabinet edge, grill frame or other similar object.

Diaphragm. A thin flexible membrane or cone that vibrates in response to electrical signals to produce sound waves.

Distortion. Usually referred to in terms of total harmonic distortion (THD) which is the percentage of unwanted harmonics of the drive signal present with the wanted signal. Generally used to mean any unwanted change introduced by the device under question.

Driver. See transducer.

Dynamic Range. The range between the quietest and the loudest sounds a device can handle (often quoted in dB).

Efficiency. The acoustic power delivered for a given electrical input. Often expressed as decibels/watt/meter (dB/w/m).

ESL. The abbreviation for electrostatic loudspeaker.

Headroom. The difference, in decibels, between the peak and RMS levels in program material.

Hybrid. A product created by the marriage of two different technologies. Meant here as the combination of a dynamic woofer with an electrostatic or ATF transducer.

Hz (Hertz). Unit of frequency equivalent to the number of cycles per second.

Imaging. To make a representation or imitation of the original sonic event.

Impedance. The total opposition offered by an electric circuit to the flow of an alternating current of a single frequency. It is a combination of resistance and reactance and is measured in ohms. Remember that a speaker's impedance changes with frequency, it is not a constant value.

Inductance. The property of an electrical circuit by which a varying current in it produces a varying magnetic field that introduces voltages in the same circuit or in a nearby circuit. It is measured in henrys.

Inductor. A device designed primarily to introduce inductance into an electrical circuit. Sometimes called a choke or coil.

Linearity. The extent to which any signal handling process is accomplished without amplitude distortion.

Midrange. The middle frequencies where the ear is the most sensitive.

NAC. The abbreviation for natural ambience compensation.

Passive crossover. Uses no active components (transistors, ICs, tubes) and needs no power supply (AC, DC, battery) to operate. The crossover in a typical loudspeaker is of the passive variety. Passive crossovers consist of capacitors, inductors and resistors.

Phase. The amount by which one sine wave leads or lags a second wave of the same frequency. The difference is described by the term phase angle. Sine waves in phase reinforce each other; those out of phase cancel.

Pink noise. A random noise used in measurements, as it has the same amount of energy in each octave.

Polarity. The condition of being positive or negative with respect to some reference point or object.

RMS. Abbreviation for root mean square. The effective value of a given waveform is its RMS value. Acoustic power is proportional to the square of the RMS sound pressure.

Resistance. That property of a conductor by which it opposes the flow of electric current, resulting in the generation of heat in the conducting material, usually expressed in ohms.

Resistor. A device used in a circuit to provide resistance.

Resonance. The effect produced when the natural vibration frequency of a body is greatly amplified by reinforcing vibrations at the same or nearly the same frequency from another body.

Sensitivity. The volume of sound delivered for a given electrical input.

Stator. The fixed part forming the reference for the moving diaphragm in a planar speaker.

THD. The abbreviation for total harmonic distortion. (See Distortion)

TIM. The abbreviation for transient intermodulation distortion.

Transducer. Any of various devices that transmit energy from one system to another, sometimes one that converts the energy in form. Loudspeaker transducers convert electrical energy into mechanical motion.

Transient. Applies to that which lasts or stays but a short time. A change from one steady-state condition to another.

Tweeter. A small drive unit designed to reproduce only high frequencies.

Wavelength. The distance measured in the direction of progression of a wave, from any given point characterized by the same phase.

White noise. A random noise used in measurements, as it has the same amount of energy at each frequency.

Woofers. A drive unit operating in the bass frequencies only. Drive units in two-way systems are not true woofers but are more accurately described as being mid/bass drivers.

NOTES





MARTIN LOGAN®
the loudspeaker technology company

Lawrence, Kansas, USA tel 785.749.0133 fax 785.749.5320 www.martinlogan.com

©2005 MartinLogan. All rights reserved.

Rev. #112405