

THETA DIGITAL

C O R P O R A T I O N

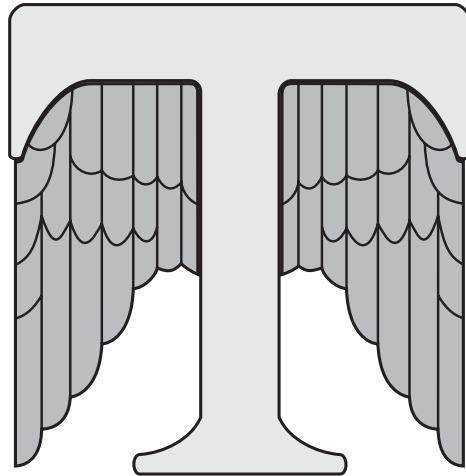

Generation VIII

Owner's Manual

V 1.04

Digital Done Right

™

PREFACE

CONGRATULATIONS

You have just acquired the most advanced component for the processing and conversion of digital to analog signals to have been developed.

IMPORTANT

Save all packaging in a dry place away from fire hazards. Your Generation VIII is a precision electronic instrument and should be properly packaged any time shipment is made. In the unlikely event that you have to return your Generation VIII to the factory for service, or if you send it to us for updating, the original packaging will best protect the unit from shipping damage.

In order to achieve the fullest flexibility and enjoyment from your Generation VIII, we at Theta recommend that you read this manual in full before connecting the unit to your audio/video system.

WARNING

United States law prohibits disposition of these commodities to Libya, Laos, North Korea, Cambodia or Cuba unless otherwise authorized by the United States.

NOTE:

This equipment has been tested and found to comply with the limits for a Class B digital device, pursuant to Part 15 of the FCC rules. These limits are designed to provide reasonable protection against harmful interference in a residential installation. This equipment generates, uses and can radiate radio frequency energy and, if not installed and used in accordance with the instructions, may cause harmful interference to radio communications. However, there is no guarantee that interference will not occur in a particular installation. If this equipment does cause harmful interference to radio and television reception, which can be determined by turning the equipment off and on, the user is encouraged to try to correct the interference by one or more of the following measures:

- * Reorient or relocate the receiving antenna.
- * Increase the separation between equipment and receiver.
- * Connect the receiver into an outlet on a circuit different from that to which the Generation VIII is connected.

Acknowledgments

© 2003 Theta Digital Corporation. All rights reserved.
Written and illustrated by Glenn Buckley.

This manual is also available for download as a PDF file at Theta Digital's website: <http://www.thetadigital.com>

No part of this publication may be reproduced or transmitted in any form or by any means, electronic or mechanical, for any purpose, without the express written permission of Theta Digital Corporation.

	CAUTION RISK OF ELECTRICAL SHOCK DO NOT OPEN	
CAUTION: TO REDUCE THE RISK OF ELECTRICAL SHOCK, DO NOT REMOVE COVER (OR BACK) NO USER-SERVICEABLE PARTS INSIDE REFER SERVICING TO QUALIFIED SERVICE PERSONNEL		

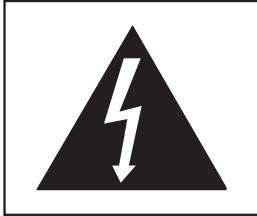

The lightning flash with arrowhead symbol, within an equilateral triangle, is intended to alert the user to the presence of uninsulated “dangerous voltage” within the product’s enclosure that may be of significant magnitude to constitute a risk of electric shock to persons.



The exclamation point within an equilateral triangle is intended to alert the user to the presence of important operating and maintenance (servicing) instructions in the literature accompanying the product.

WARNING

**TO REDUCE THE RISK OF FIRE OR ELECTRIC SHOCK,
DO NOT EXPOSE THIS PRODUCT TO RAIN OR MOISTURE**

CAUTION: TO PREVENT ELECTRIC SHOCK, DO NOT USE THE (POLARIZED) PLUG WITH AN EXTENSION CORD, RECEPTACLE OR OTHER OUTLET UNLESS THE BLADES CAN BE FULLY INSERTED TO PREVENT BLADE EXPOSURE.

Generation VIII Identification Record

This information is for your records and for future identification of the Generation VIII. Please take a moment to fill out all pertinent data now, and as upgrades and/or options are installed. **Whenever upgrades, inquiries, service, repair and/or changes are requested, the serial number will be required.**

SERIAL NUMBER _____

DATE PURCHASED _____

DEALER'S NAME _____

DEALER'S ADDRESS/PHONE _____

INSTALLED CARDS/OPTIONS/UPGRADES _____
(Date of installation)

(Date of installation)

(Date of installation)

(Date of installation)

(Date of installation)

(Date of installation)

SAFETY PRECAUTIONS

Please carefully read each item of the operating instructions and safety precautions before using this product. Use extra care to follow the warnings written on the product itself and/or in the operating instructions. Keep the operating instructions and safety precautions for future reference.

CAUTION: TO REDUCE THE RISK OF ELECTRICAL SHOCK, DO NOT REMOVE ANY OF THE COVER PANELS.

NO USER-SERVICEABLE PARTS INSIDE. REFER ALL SERVICING TO QUALIFIED SERVICE PERSONNEL ONLY.

TO PREVENT FIRE OR SHOCK HAZARD, DO NOT ALLOW LIQUIDS TO SPILL OR OBJECTS TO FALL INTO ANY OPENINGS OF THE PRODUCT.

THIS UNIT IS SUPPLIED WITH A 3 PIN GROUNDED AC PLUG. ALWAYS INSERT THE AC PLUG INTO A GROUNDED OUTLET. DO NOT REMOVE THE GROUND PIN OR DISABLE THE GROUND FOR ANY PURPOSE.

BEFORE MAKING ANY CONNECTIONS TO THE GENERATION VIII, FIRST TURN OFF THE POWER AND THEN DISCONNECT THE AC POWER CORD.

WHEN INSTALLING THE GENERATION VIII IN YOUR SYSTEM, MAKE CERTAIN TO ALLOW A MINIMUM OF 3 INCHS OF VENTILATION ON EACH SIDE OF THE UNIT. ALSO ALLOW AT LEAST 3½ INCHS OF VENTILATION SPACE ABOVE THE UNIT. IMPROPER VENTILATION OF THE UNIT MAY CAUSE OVERHEATING, WHICH MAY DAMAGE THE UNIT AND CAUSE A FIRE. PLACE THE UNIT ON A SOLID SURFACE ONLY. I.E. NOT ON CARPET, ETC.

DO NOT PLACE THE GENERATION VIII NEAR HEAT SOURCES SUCH AS DIRECT SUNLIGHT, STOVES, HEAT REGISTERS, RADIATORS OR OTHER HEAT PRODUCING EQUIPMENT.

TO PREVENT DAMAGE TO THE ANALOG OUTPUT CIRCUITRY, BE CERTAIN NOT TO SHORT THE OUTPUT SIGNAL PIN(S) TO GROUND. ENSURE THAT YOUR AUDIO OUTPUT CABLES DO NOT HAVE ANY INTERNAL SHORTS BEFORE CONNECTING THEM TO THE GENERATION VIII.

IF REPLACEMENT OF THE AC LINE FUSE BECOMES NECESSARY, REPLACE ONLY WITH SAME VALUE AND TYPE OF FUSE. NEVER BYPASS THE FUSE.

IF THE AC CORD BECOMES DAMAGED, DO NOT USE IT. IMMEDIATELY REPLACE IT WITH A NEW ONE OF THE SAME OR BETTER RATING.

AFTER MARKET and THIRD PARTY MODIFICATIONS

Please note that any after market and/or third party modifications will void the warranty. In the case of changing the feet on a unit, in order to prevent any damage (which will also not be covered under warranty), please verify that the screws being used to secure non Generation VIII feet do not screw any deeper into the chassis than the original ones. The original screw is 1/4-20 by 3/8 and goes into the chassis 1/4 inch MAX.

Table of Contents

PREFACE	ii
WARNING	iii
Generation VIII Identification Record	iv
SAFETY PRECAUTIONS	v
List of Figures.....	vii
List of Tables.....	vii
INTRODUCTION	1
Getting to know your Generation VIII.....	1
IMPORTANT NOTICE	2
Reference Manual Conventions.....	2
Glossary of Terms and Abbreviations.....	3
Generation VIII Block Diagram	4
Front Panel Layout.....	5
Rear Panel Layout	6
Menu Maps	7
Setup Menu Pages.....	7
Remote Control.....	8
Introduction to the User interface.....	9
OPERATIONS	10
Input Select Buttons	10
Changing Inputs	10
SETUP	11
Jack and Input Names.....	11
Clocking.....	12
Burning In	12
Remote Triggering.....	13
RS232.....	13
IR Source.....	14
Using Generation VIII as an External DAC	14
Screensaver	15
Initial Volume Level	15
Serial Number/Software Versions	16
BALANCE Function.....	16
APPENDIXES	17
Appendix A Troubleshooting Guide	18
Appendix B Wiring Diagrams	19
Appendix C Remote Extender Jack Technical Description and Protocol	21
Appendix D RS232 Protocol.....	22
RS232 Hardware Connections.....	22
Appendix E Specifications.....	27
Warranty Information	29

List of Figures

Figure 1 - Generation VIII Block Diagram	4
Figure 2 - Front Panel Layout.....	5
Figure 3 - Rear Panel Layout	6
Figure 4 - Setup Menu Pages.....	7
Figure 5 - Remote Control	8
Figure 6 - Front Panel Display of the INPUT SELECT page.....	10
Figure 7 - Front Panel Display of the INPUT SELECT page when Fixed Volume Controls are installed.....	10
Figure 8 - Front Panel Display of the SETUP page 1 - Names.....	11
Figure 9 - Front Panel Display of the SETUP page 2 – Input Clocking.....	12
Figure 10 - Front Panel Display of the SETUP page 3 – Burn In Signal.....	12
Figure 11 - Front Panel Display of the SETUP page 4 – Remote Trigger	13
Figure 12 - Front Panel Display of the SETUP page 5 – RS 232	13
Figure 13 - Front Panel Display of the SETUP page 6 – IR Source	14
Figure 14 - Front Panel Display of the SETUP page 7 – Ext Vol	15
Figure 15 - Front Panel Display of the SETUP page 8 – Screensaver	15
Figure 16 - Front Panel Display of the SETUP page 9 – Initial Volume.....	16
Figure 17 - Front Panel Display of the SETUP page 10 – Info	16
Figure 18 - Front Panel Display of the Balance Menu.....	16
Figure 19 - Examples of Typical In and Out Connections.....	19
Figure 20 - Example of Connections to/from a Casablanca II Digital Out Card.....	20

List of Tables

Table 1 - Glossary of Terms and Abbreviations	3
Table 2 – Display Jack Name Abbreviations & Definitions	11
Table 3 – Troubleshooting Guide	18

INTRODUCTION

Welcome to a new world of possibilities. Generation VIII is by far the most advanced digital to analog converter available today. It offers the advantages of Theta's legendary mastery in digital signal processing and sound quality unapproachable by any other equipment.

Getting to know your Generation VIII

Despite the Generation VIII's great technical sophistication, we believe in making it as easy as possible for you to use. We think you'll enjoy the intuitive way the Generation VIII works. Rather than offer a frustrating bewilderment of little used functions in constant view, vying for your attention, Generation VIII is structured systematically by function.

This Generation VIII has been put through a rigorous and unique testing procedure that insures that it will last for many years with minimal service requirements. This procedure includes the following:

- All assembled circuit boards are given a thorough visual inspection and are then tested in a bench-reference Generation VIII.
- The tested, assembled circuit boards are then installed in a new Generation VIII and the whole unit is tested for every function and parameter.
- The unit is put on a burn-in torture rack for 100 hours to test for any possible component failures.
- The Generation VIII is tested on an audio analyzer for all pertinent parameters.
- The Generation VIII is put through a final bench test wherein every possible feature, mode and parameter is checked.
- The unit has all remaining chassis components installed and then undergoes a complete visual inspection, which assures that all Generation VIII's meet visual specifications.
- The unit is then put through a critical listening test.

Burn In Time

This unit has a break in period of about 1 week during which continuous improvement in sound quality will be observed. It is recommended that music or the internal burn-in signal be played continuously through the unit during this time to expedite the break in period.

IMPORTANT NOTICE

- I. Due to the computer-based circuitry used in Theta products, it is imperative that the Generation VIII be connected to a ground via its three wire AC power cord. It is important that the AC power outlet which the Generation VIII is plugged into is actually grounded. Failure to do so will severely compromise the performance, reliability and safety of use of the Generation VIII.
- II. It is also important to prevent discharge of static electricity when connecting other components and cables to the Generation VIII. When connecting cables, simply place one hand on top of the Generation VIII and then grasp the metal "barrel" of the cable with the other hand and plug (unplug) the cable into (from) the appropriate jack on the Generation VIII.
- III. The Generation VIII, as with all electronic equipment, is susceptible to static discharges. Resetting the unit may be required if anomalies occur after receiving a static discharge. In this case, put the unit in standby and turn off the rear panel power switch for 2 minutes, and then turn it on again.
- IV. Ventilation is an important issue when placing the Generation VIII in a system. Make certain that the Generation VIII is placed in a well-ventilated area or rack unit. There must be a clear path for cool air to get into the unit, and for heat to escape.
- V. Please take note that some powerline conditioners defeat the AC power ground on their outlets. If the intention is to plug the Generation VIII into a line conditioner, check with your dealer to make certain that the particular conditioner that is intended for use DOES NOT DEFEAT THE AC GROUND on its AC outlets.
- VI. DO NOT remove any cover panels from the Generation VIII, as there are no user serviceable components inside. Refer updating and servicing to Theta qualified service personnel only.
- VII. Should the Generation VIII need to be reset, it must be put in standby first via the front panel power button. Then the rear panel power switch is to be turned off for at least 2 minutes.
- VIII. The Generation VIII can be susceptible to excessive RF. End caps in all unused inputs will improve the sound quality and may reduce the susceptibility to RF induced anomalies.

Reference Manual Conventions

For clarity purposes, references to buttons, LED's and display parameters will be shown in bold capital letters.

Glossary of Terms and Abbreviations

TERM	DEFINITION
AES/EBU (Audio Engineering Society) / (European Broadcasters Union)	A three wire balanced digital audio standard. This interface uses a 3-pin XLR type connector and allows for data communication between digital audio equipment.
Analog-to-Digital Converter	A device that converts analog signals into a digital format. Once encoded, all audio is stored or processed as a series of numbers rather than as the audio itself.
Balanced Audio Signals	Signals that are carried on three-conductor cables, with two of the conductors carrying the same signal 180° out of phase and the third as ground. Balanced connections usually cost more than unbalanced connections, but are less susceptible to picking up hum and prevent interference with low-level signals.
dB	Decibel, a relative unit of loudness.
Digital-to-Analog Converter (DAC)	A device that converts digital signals into an analog format.
DSP	Digital Signal Processor (Processing)
Hz (Hertz)	A unit of frequency.
IR	Infrared. A wireless method of data transmission.
mS	Millisecond, or 1/1000 of a second.
Oversampling	The process of taking more samples than is required in order to more accurately reconstruct a digitized signal for playback in the analog domain.
Sampling Rate	The rate at which an analog (real world) signal is converted into digital numeric values.
Single-Ended or SE, aka Unbalanced Audio Signals	Signals that are carried on two-conductor cables, one “hot”, or signal, and one ground.
S/PDIF Interface (Sony/Phillips Digital Interface format)	A digital audio interconnection standard, developed jointly by Sony and Phillips.
TRS	Tip, Ring, Sleeve. Names of the 3 connecting elements of a stereo phono jack or plug.
VFD	Vacuum Florescent Display

Table 1 - Glossary of Terms and Abbreviations

Generation VIII Block Diagram

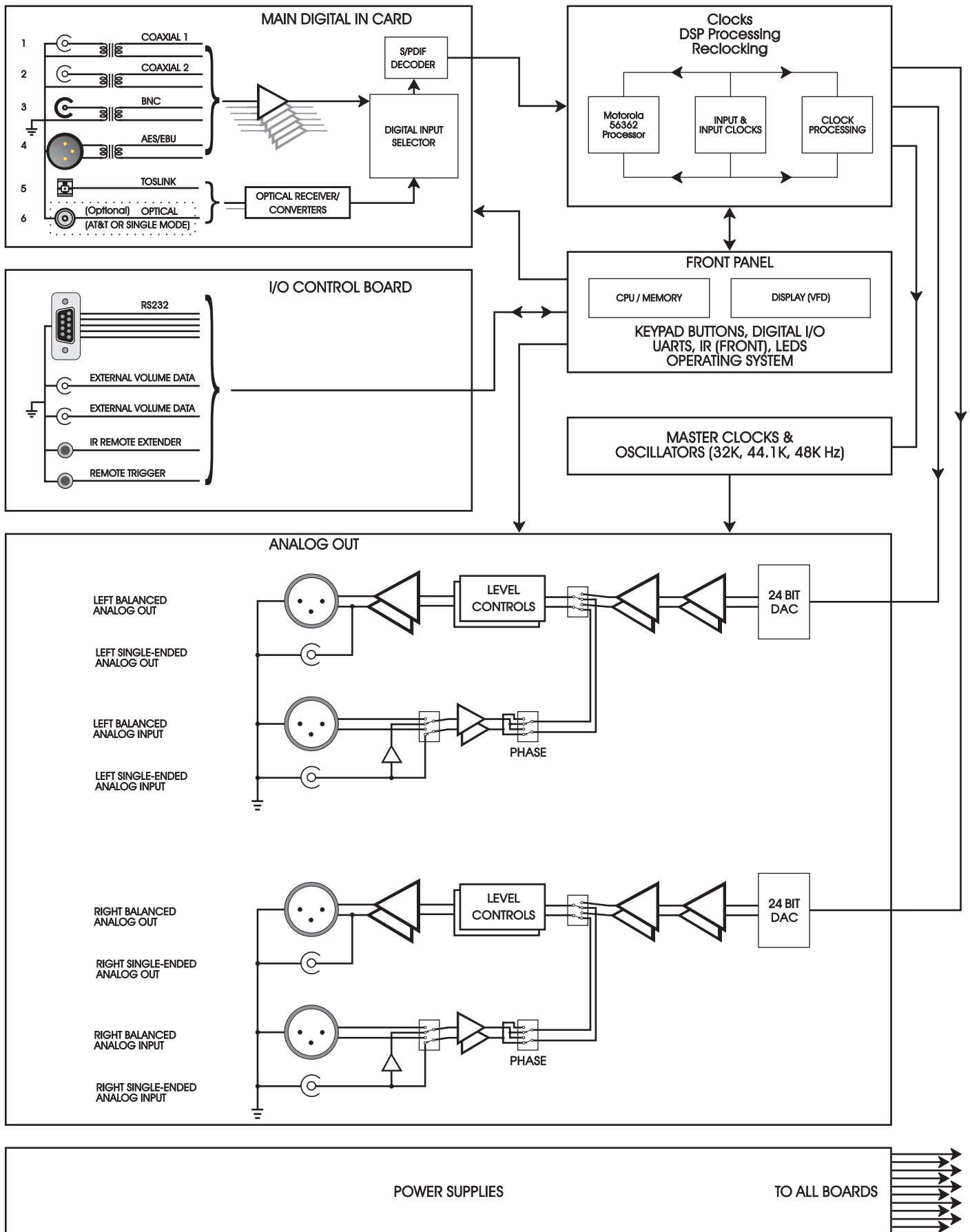

Figure 1 - Generation VIII Block Diagram

Front Panel Layout

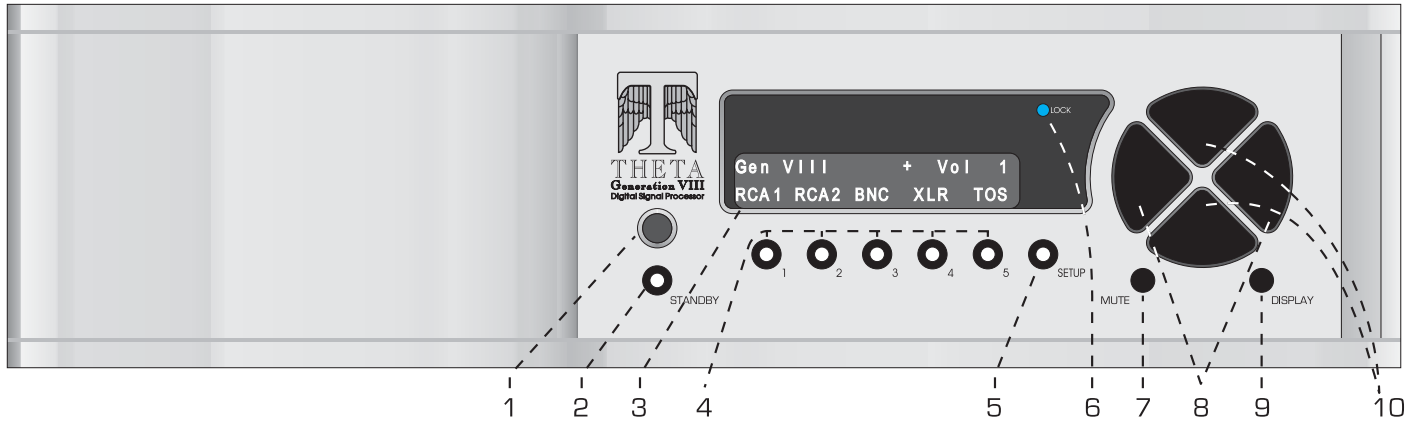

Figure 2 - Front Panel Layout

1. Remote IR receiver.
2. **STANDBY** button/LED. After the rear panel **MAIN POWER** switch is turned on, press the front panel **STANDBY** button to exit the standby mode. The Generation VIII will quickly initialize. The VFD will default to the last selected **INPUT**. Pressing **STANDBY** again will place the Generation VIII into standby mode and the LED in the front panel **STANDBY** button will light. Each time the Generation VIII is put into standby, the VFD will “exercise” itself for 10 seconds by illuminating all pixels. (This will enhance the lifetime of the VFD).
3. 24 character by 2 row Vacuum Florescent Display (VFD).
4. Buttons **1** through **5**. Used to select a desired **INPUT**, or parameter to change in the **SETUP** menus. The LED in the button lights when the button is pressed. These buttons are referred to as the **INPUT SELECT** buttons.
5. **SETUP** button. Used to access the **SETUP** menus, for setting all user parameters.
6. **LOCK** light. Lights when a valid digital signal is detected on the currently selected input.
7. **MUTE** button. Mutes/unmutes all audio outputs. Not active when optional fixed volume cards are installed.
8. **LEVEL LEFT** and **RIGHT** buttons. Shifts audio balance to the left and right, or adjusts the master volume within submenus when the **LEVEL UP/DOWN** buttons are to be used for editing parameter values.
9. The **DISPLAY** button will toggle the VFD brightness between off, $\frac{1}{4}$, $\frac{1}{2}$, $\frac{3}{4}$ and full brightness.
10. **LEVEL UP** and **DOWN** buttons. Increases/decreases master volume. Also used to increment/decrement values in the **SETUP** menus.

Rear Panel Layout

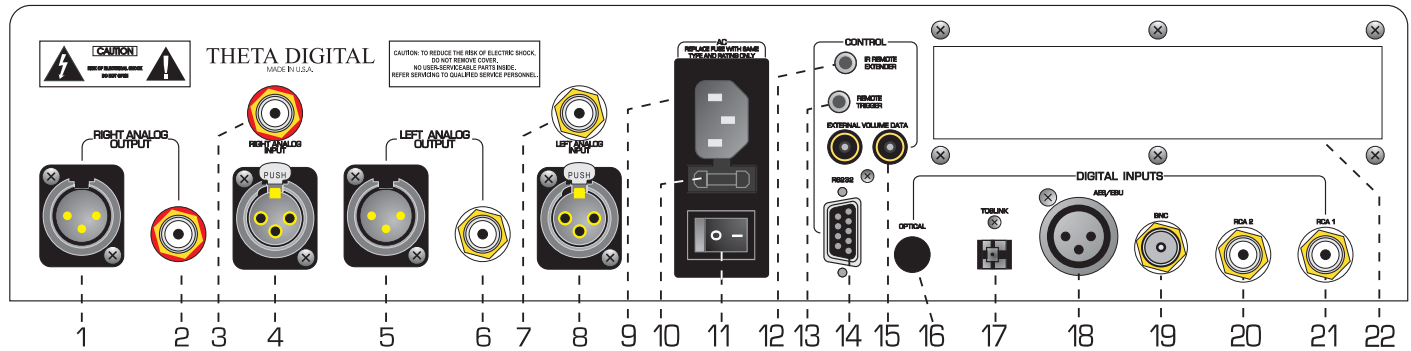

Figure 3 - Rear Panel Layout

1. Right Balanced Output.
2. Right Single-Ended Output (RCA).
3. Right Analog Input (RCA)
4. Right Balanced Analog Input.
5. Left Balanced Output.
6. Left Single-Ended Output (RCA).
7. Left Analog Input (RCA)
8. Left Balanced Analog Input.
9. **AC Power** input connector: 3 wire, IEC 320 standard with an EMI filter.
10. Fuse Holder. Fuse @ 100 & 110V = 630mA/250V, Fuse @ 220V = 3/8A/250V.
11. **Main Power Switch.** Master power switch. Disconnects AC to all circuits. It is recommended that this be left ON at all times during regular use with the exception of whenever cables are connected/disconnected or when the unit is not going to be used for an extended period of time. When this switch is turned on, the display will momentarily show the unit's serial number.
12. **IR Remote Extender** jack. An externally mounted (remote) Infrared Receiver (IR) plugs into this miniature stereo phono jack. The signal must be demodulated. Please refer to Appendix C on page 21 for additional information.
13. **Remote Trigger** jack. Activated/deactivated (toggle) when the **STANDBY** button is pressed. The trigger can be set to be either an input or output and function with either 12VDC or a 12V pulse (variable duration). The default is a DC Output.
14. **RS232** connector (DB9).
15. **External Volume Data** inputs. When the Generation VIII is used as an external DAC with the Theta Casablanca or Casa Nova, output volume can be controlled from the processor. This is a proprietary digital data input.
16. Optional optical input (AT&T)
17. TosLink optical input
18. AES/EBU Digital input.
19. BNC digital input
20. Coaxial digital input # 2 (RCA)
21. Coaxial digital input # 1 (RCA)
22. Future Options port.

Menu Maps

Setup Menu Pages

Within the Setup feature, following are all possible Setup menu pages:

Input Jack	Name	10	
1	RCA1	RCA1	>

Input Clocking		10	
1	Jitter Jail		>

Burn in Signal		10	
Off			>

Rem. Trig	I/O Pulse	10	
Out, DC	50ms		>

RS- Rate	EchoStatus	10	
232 57600	No		>

I.R. Remote Source		10	
Front Panel			>

Ext Vol Sig Channels		10	**
None			

Screensaver Time		10	
10 min			>

Initial Volume Level		10	**
20			>

S/N	Ver	DSP	10
00000	1.00	1.00	>

** Not accessible when fixed volume option is installed.

Figure 4 - Setup Menu Pages

Remote Control

1. **Standby** button. After the rear panel **MAIN POWER** switch is turned on, press the front panel **STANDBY** button to exit the standby mode. The Gen VIII will quickly initialize. The VFD will default to the last selected **INPUT**. Pressing **STANDBY** again will place the Generation VIII into standby mode and the LED in the front panel **STANDBY** button will light. Each time the unit is put into standby, the VFD will “exercise” itself for 10 seconds by illuminating all pixels. (This will enhance the lifetime of the VFD). The Standby button is inactive when the Generation VIII is in **SETUP**.
2. **Input Select** buttons 1 through 5. Used to select a desired **INPUT**, or to change a parameter when in a submenu. The LED in the button lights when the button is pressed.
3. The **DISPLAY** button will cycle the VFD brightness through full brightness, $\frac{3}{4}$, $\frac{1}{2}$, $\frac{1}{4}$ and off.
4. **Mute** button. Mutes/unmutes all audio outputs. Not active when optional fixed volume cards are installed.
5. **Setup** button. Used to enter/exit the **SETUP** menus, when setting all user parameters.
6. **Level Up/Down** buttons. Increases/decreases master volume. Also used to increment/decrement values in the **SETUP** menus.
7. **Level Left/Right** buttons. Shifts audio balance to the left and right, or adjusts the master volume within submenus when the **LEVEL UP/DOWN** buttons are used for parameter value editing.
8. **Phase** button. Toggles the phase (0-180°) of all speaker outputs.

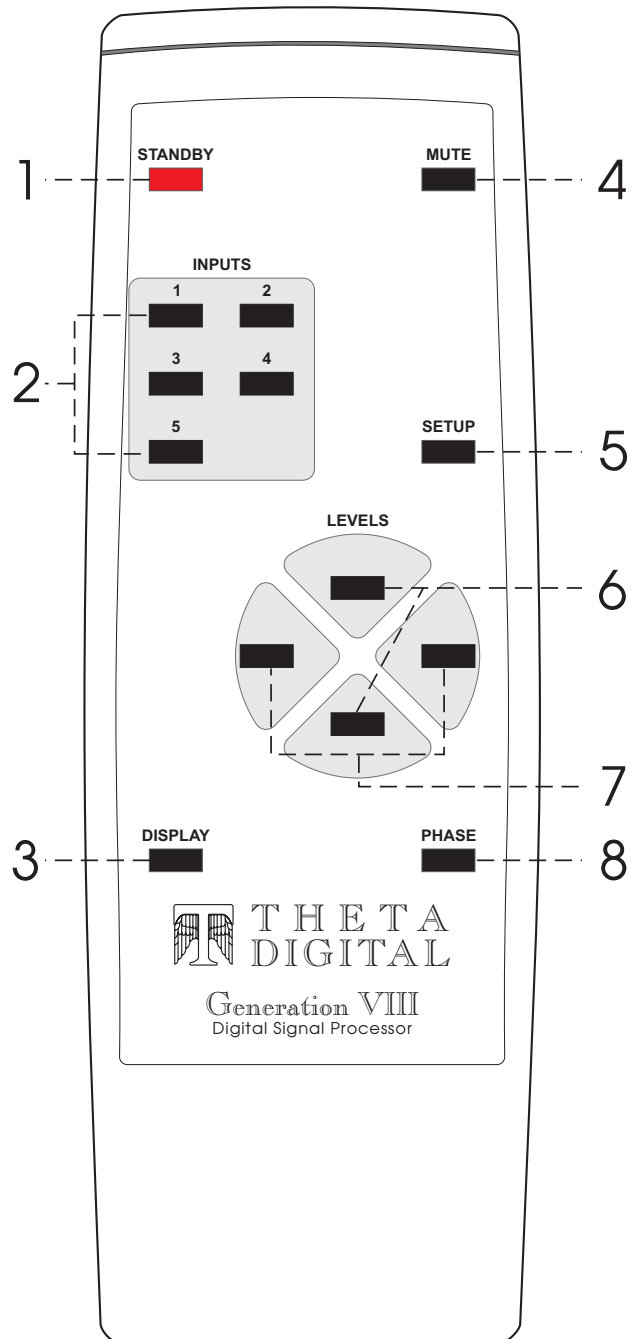

Figure 5 - Remote Control

Note: When operating the hand held remote control, point it at the remote sensor on the Generation VIII's front panel. The remote control can be used 3 to 20 feet from the Generation VIII and within a 30° angle from each side of the sensor. Exposing the remote sensor to direct sunlight or strong light may cause faulty operation.

Introduction to the User interface

The menu system within the Generation VIII is no deeper than 2 layers. When the **SETUP** button is pressed the first setup page is shown. There is a ">" symbol above the # 5 button at all times when in Setup. This indicates that there is another page of setup parameters. While in setup, simply pressing button # 5 repeatedly will take the user through all of the **SETUP** pages. This is a loop and will ultimately bring the user back to the first **SETUP** page. Please refer to Figure 4 for an overall view of all **SETUP** menus.

The first two **SETUP** menu pages contain parameters that can be stored uniquely for each of the five **INPUT SELECT** buttons. The remaining **SETUP** pages are parameters which are global to the Generation VIII.

Once a parameter is selected for editing, pressing the **LEVEL UP/DOWN** buttons edits the parameter value, storing it at the same time. On any **SETUP** page, the **LEVEL LEFT/RIGHT** buttons will adjust the master volume.

To exit the **SETUP** menu, simply press the **SETUP** button again.

* * *

In the past, Theta has offered various options with their products. With the Generation VIII, most of these options are pre-installed into the 'base' model. One important option remains - the ability to have the Generation VIII be both a processor and a preamp. This is achieved by having either fixed volume controls or variable volume controls installed at the time of purchase.

This manual describes the operations and menus as if the variable volume controls are installed. In each section, menus, structures and instructional changes are indicated where they apply to a Generation VIII with fixed volume controls.

OPERATIONS

This section describes the functionality of each button on the Generation VIII's front panel.

Input Select Buttons

When the Generation VIII is first powered up via the **MAIN POWER** switch on the back panel, it will check all installed software and hardware, momentarily display the unit serial number, and then revert to the standby mode. The **STANDBY** LED will be lit.

After pressing the **STANDBY** button on the front panel, the display will show the start-up routine and then the **INPUT SELECT** page, shown below in Figure 6. As this menu appears, the **STANDBY** LED turns off. This display will be on during normal operation and will change only when the **SETUP** or balance (**LEVELS LEFT/RIGHT**) buttons are pressed.

Changing Inputs

The **INPUT NAMES** shown in this figure are the default names only, and may differ from the user's setup. There are a total of 5 inputs. Buttons **1** through **5** are used to select a desired input, or audio source. The LED in the selected button will illuminate when pressed. When the Generation VIII exits the standby mode, the last active **INPUT SELECT** will be selected.

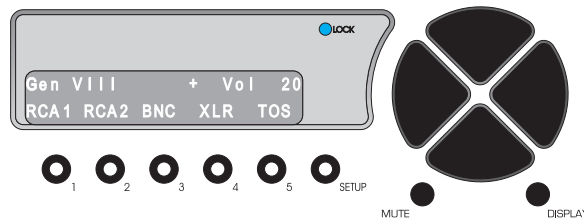

Figure 6 - Front Panel Display of the INPUT SELECT page

Pressing the **LEVEL UP/DOWN** buttons will adjust the master volume for all speakers. This value ranges from **0** to **86**, relative maximum.

It is important to note that if the Fixed Volume Control option is installed, the “**Vol**” parameter in the display will indicate the word “**Fixed**”. If the **LEVEL UP/DOWN**; **MUTE**; and/or **BALANCE** buttons are pressed, the word **Fixed** will flash and the above mentioned buttons will have no effect. An example of this menu is shown in Figure 7 below.

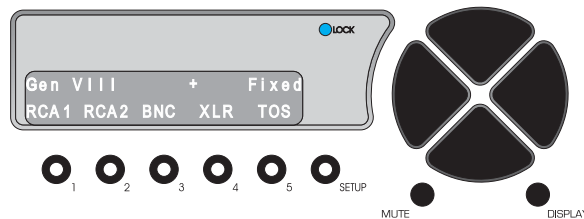

Figure 7 - Front Panel Display of the INPUT SELECT page when Fixed Volume Controls are installed

* * *

The **DISPLAY** button will cycle the VFD brightness through full brightness, $\frac{3}{4}$, $\frac{1}{2}$, $\frac{1}{4}$ and off.

The **MUTE** button mutes/unmutes all audio outputs. Not active when optional fixed volume cards are installed.

SETUP

This function provides access to a series of submenus that will allow the configuration of the Generation VIII. In this section, each feature of the **SETUP** menu is discussed in detail along with a diagram of each VFD display.

Pressing the **SETUP** button once changes the front panel display to the first page of the **SETUP** menu, shown in Figure 8. Pressing button # **5** (>) allows the user to enter into a series of Setup menu pages that permit the configuration of all parameters that are programmable, both by **INPUT SELECT** button and global.

The master volume level is shown in the upper right corner of each **SETUP** menu.

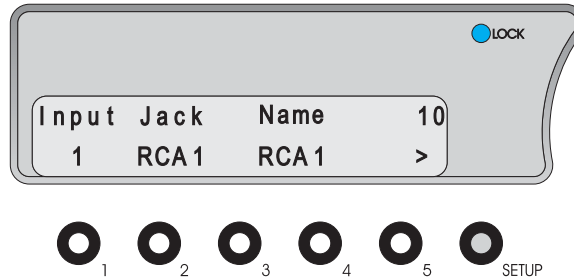

Figure 8 - Front Panel Display of the SETUP page 1 - Names

Jack and Input Names

Each physical input jack can be assigned, or “mapped” to any **INPUT SELECT** button. **INPUT SELECT** button names can be changed.

Pressing button # **1** allows the user to select which **INPUT** is to be edited. Use the **LEVEL UP/DOWN** buttons to change the parameter.

Use button # **2** to reassign a rear panel input jack to the front panel **INPUT SELECT** button that is shown in the display above button # **1**.

Button # **4** allows the user to select a name for the currently selected **INPUT**. In Figure 8, the rear panel **RCA 1** jack is mapped to **INPUT SELECT** button # **1** and **INPUT SELECT** # **1** is named **RCA 1**.

Jack Names	Definition
RCA 1	Rear panel RCA 1 input jack
RCA 2	Rear panel RCA 2 input jack
BNC	Rear panel BNC input jack
XLR	Rear panel AES/EBU input jack
TOS	Rear panel TosLink input jack
Optical	Rear panel Optical input jack
Ana Bal	Rear panel Balanced Analog input jack
Ana S.E.	Rear panel Single-Ended Analog input jack

Table 2 – Display Jack Name Abbreviations & Definitions

The possible **INPUT SELECT** names are as follows:

RCA1, RCA 2, BNC, XLR, TOS, Opti, Abal, A se, CD, CD 1, CD 2, DVD, DVD1, DVD2, Phon, Tune, AM, FM, TV, and “number”. If ‘**number**’ is selected, the name will be the number of the currently selected **INPUT SELECT**.

From this **SETUP** menu, pressing button # **5** takes the user to the second page, shown in Figure 9.

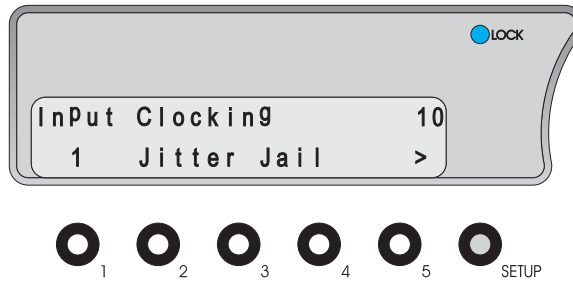

Figure 9 - Front Panel Display of the SETUP page 2 – Input Clocking

In this menu the user can first select the **INPUT** to which the clocking type is applied (button # 1), then select the choice of clocking.

Press the **SETUP** button once to exit the menu.

Clocking

A reclocking circuit typically converts poor quality jitter-ridden inputs into a high-quality transformer-isolated coaxial output. The Generation VIII uses this standard design to reclock. The Generation VIII also has an advanced proprietary synthesized anti-jitter circuit known as “Jitter Jail”. Either clocking type can be selected by the user, via button # 2.

Press the **SETUP** button once to exit the menu.

Note: When using multiple Generation VIII's with a single source it is best to select **Reclocking** so that each Generation VIII's data clock will be synchronized with the incoming data clock.

Burning In

All new in-circuit devices and cables require a burn in period. The Generation VIII provides a white noise that can be used to evenly expedite this process. Connect all component devices and cables in the system and go to the “**Burn in signal**” menu. (**SETUP**, # 5 twice).

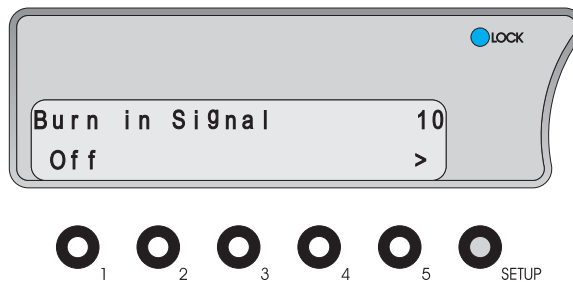

Figure 10 - Front Panel Display of the SETUP page 3 – Burn In Signal

Press button # 1 and use the **LEVEL UP/DOWN** buttons to turn the noise signal **ON** or **OFF**. The typical burn in time (when components are not turned completely off) is 60 to 100 hours.

Press the **SETUP** button once to exit the menu.

Remote Triggering

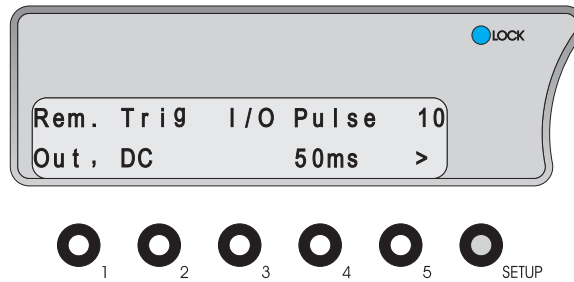

Figure 11 - Front Panel Display of the SETUP page 4 – Remote Trigger

The **REMOTE POWER** jack on the rear panel can be either an input, to allow another device to take the Generation VIII out of standby, or an output, which will allow the Generation VIII to take another device out of standby. Either way this jack is setup, it utilizes 12V and can be programmed for either straight **DC** or a **PULSE**. The Generation VIII's default is a DC Output.

The trigger is activated/deactivated by the **STANDBY** button.

Pressing **SETUP** and then the # 5 button 3 times will display the Remote Trigger menu shown in Figure 11.

Press button # 1 to select the trigger type parameter. Use the **LEVEL UP/DOWN** buttons to change the value.

The default trigger parameter is set to have the trigger send a signal (**Out**), that is 12VDC.

Pressing **LEVEL UP** once changes the out trigger to a **Pulse**.

Press **LEVEL UP** again to change the trigger to **Receive** a DC signal.

Pressing **LEVEL UP** again changes the **Receive** trigger to respond to a **Pulse**.

Press the **SETUP** button once to exit the menu.

When using a pulse In or Out, the pulse duration can be changed to match the device being triggered. Typically 50mS will work for most devices. When determining the **Pulse** value, refer to the specifications of the device that is connected to the Generation VIII's **Remote Trigger** jack and match that type and value.

The trigger circuit is current limiting. The current limiting resistor is 33 ohms (0.5W). This means that the more current a device to be triggered draws, the more the output voltage gets reduced. The formula is: Output voltage = $12 - (I \times 33)$, where I = the current draw from the triggered device, in Amperes. Refer to the device's manual for this information. The Generation VIII's maximum output current is 100mA, which, by using the above formula, means that with a 100mA draw, the output voltage will be 8.7 volts, although most triggered circuits have virtually no current draw.

RS232

This menu allows the user to set up the control parameters required for RS232 protocol interaction.

Pressing **SETUP** and the # 5 button 4 times bring up the menu shown in Figure 12.

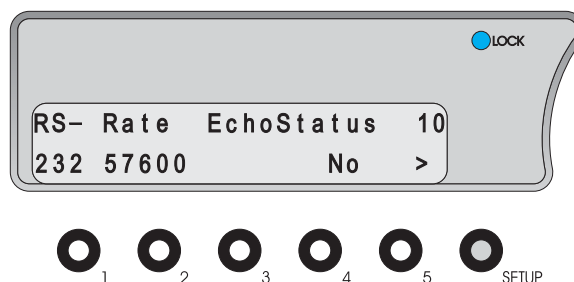

Figure 12 - Front Panel Display of the SETUP page 5 – RS 232

The default baud rate of the Generation VIII is **57600**. This can be changed by selecting button # 2 and using the **LEVEL UP/DOWN** buttons. The range of baud rates is: **4800, 9600, 19200, 38400, 57600** and **115200**.

Set the Baud **Rate** to match that of the device that is controlling/communicating with the Generation VIII.

Press the **SETUP** button once to exit the menu.

The Generation VIII can be set to automatically send changes to the RS232 port. This can be done by setting the **EchoStatus** parameter (button # 4) to **On**. This means if any Generation VIII parameter changes, all RS232 bytes will be sent to the RS232 port. This is useful for monitoring master level, input, etc. when the user has access to both the Generation VIII and the touch-panel controller, to keep them synchronized. If the user does not require any data to be sent out of the RS232 port, then set the **EchoStatus** parameter to **Off**.

The RS232 protocol is can be found in Appendix D of this manual.

IR Source

The Generation VIII can be set to respond to either the hand held remote or the rear panel IR Remote jack. It can also be set to respond to nothing. To edit this IR response parameter, press **SETUP** and the button # 5, five times. The IR Remote Source menu is shown in Figure 13.

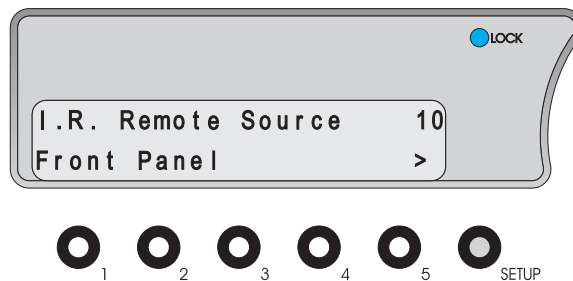

Figure 13 - Front Panel Display of the SETUP page 6 – IR Source

Press button # 1 and use the **LEVEL UP/DOWN** buttons to select the desired setting.

Press the **SETUP** button once to exit the menu.

Note: The rear panel Remote IR Extender jack requires an electrical signal that is NOT encapsulated with a modulator. See Appendix C for full details.

Using Generation VIII as an External DAC

A single or multiple Generation VIII's can be used as external DACs with Theta Casablanca's and/or Casa Nova's which are equipped with a Digital Output card. The Digital Out cards of both processors and the Generation VIII have External Volume Data jacks, which would be connected together. This allows the Master Volume control of the processor to control the volume of the Generation VIII(s), thus synchronizing the volume level adjustments of all channels.

The Generation VIII, to respond to the volume data for its assigned channels, must be set up.

This setting is accomplished in the "**Ext Vol Sig Channels**" menu, shown in Figure 14.

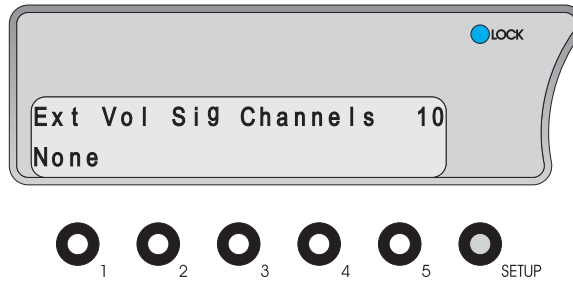

Figure 14 - Front Panel Display of the SETUP page 7 – Ext Vol

As shown in Figure 14, the Generation VIII can be set to ignore all external volume data by using the **None** setting. Otherwise the Generation VIII can be set to:

Left/Right	(Front)
Center/Sub	(Front Center/Sub1)
L/R Surr	(Left/Right Surround)
Ch. 7/8	(Sub2/Sub3)
Ch. 9/10	(Sub4/Surround Center – Sub 5)
Ch. 11/12	(Left/Right Side)

Press the **SETUP** button once to exit the menu.

Note: This menu is not available if the Fixed Volume Control option is installed.

Screensaver

The Generation VIII's VFD display will automatically dim to ¼ brightness in X minutes after the last button press. X is equal to the value set in the Screensaver menu, which is shown in Figure 15.

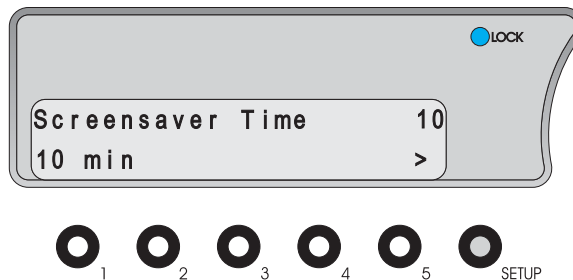

Figure 15 - Front Panel Display of the SETUP page 8 – Screensaver

This value is 10 minutes by default but can be set from 1 to 60 minutes. Use the **LEVEL UP/DOWN** buttons to change this setting. Press the **SETUP** button once to exit the menu.

Note: Pressing any button will change the display brightness to full for X minutes.

Initial Volume Level

When the Generation VIII first comes out of standby its volume, by default, will be **20**. This parameter can be changed to reflect the user's preference by pressing the **SETUP** button once, and then the # **5** button eight times. The Initial Volume Level menu is shown in Figure 16.

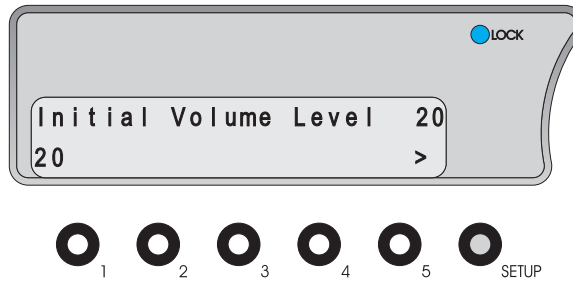

Figure 16 - Front Panel Display of the SETUP page 9 – Initial Volume

Use the **LEVEL UP/DOWN** buttons to change the value and then press **SETUP** to exit this menu.

Note: This menu is not available if the Fixed Volume Control option is installed.

Serial Number/Software Versions

The serial number and the software versions of the Generation VIII can be read by pressing **SETUP** once and then button # 5 nine times (Seven if the Fixed Volume option is installed). This menu is shown in Figure 17.

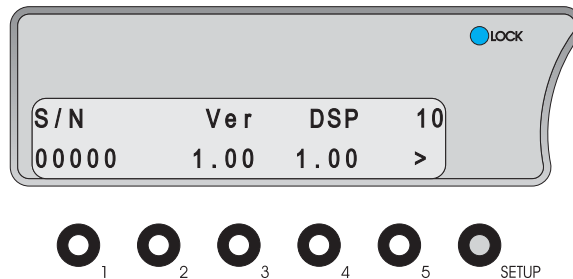

Figure 17 - Front Panel Display of the SETUP page 10 – Info

Above button # 1 is the serial number, above button # 3 is the Operating System version number and above button # 4 is the DSP software version number.

Press **SETUP** to exit this menu, or button # 5 to go to the first **SETUP** page.

BALANCE Function

This function allows the user to temporarily set the **Left/Right** balance for the currently selected **INPUT**. If the user presses a different **INPUT SELECT** button, or puts the unit into standby, the balance will return to its center position, as shown in Figure 18.

From the **INPUT SELECT** menu, press **LEVEL LEFT/RIGHT** to adjust the balance.

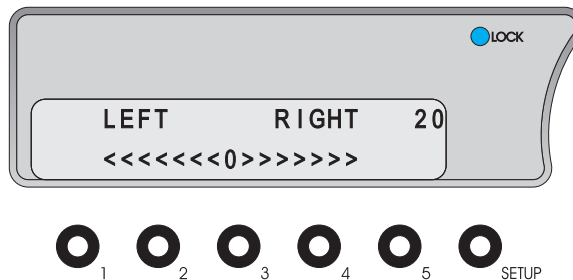
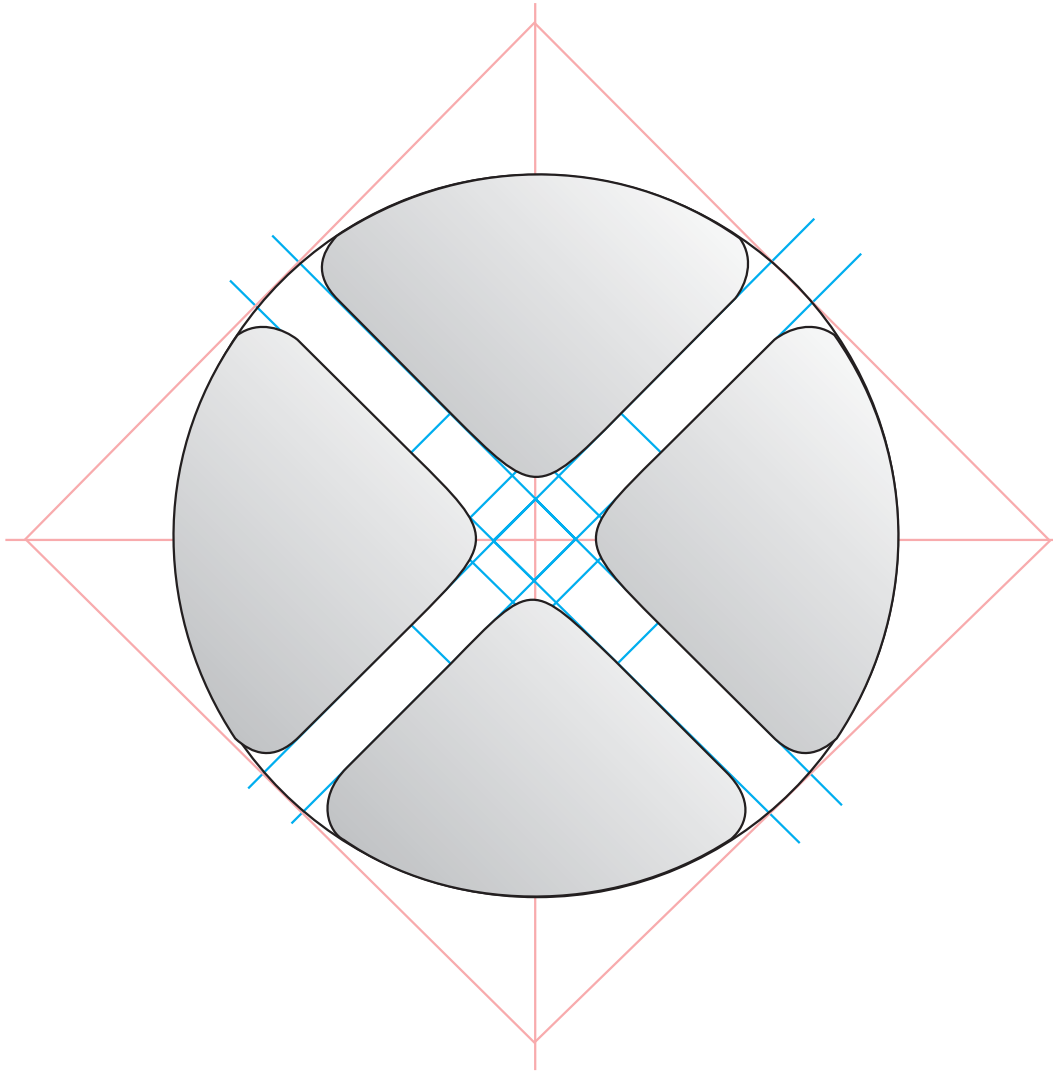

Figure 18 - Front Panel Display of the Balance Menu

The Balance menu will remain on the display for 5 seconds and then revert to the **INPUT SELECT** menu.

APPENDIXES



Appendix A Troubleshooting Guide

If the Generation VIII should function abnormally, please review the items in the following checklist. Please be sure to thoroughly check all other connected components such as speakers, amplifiers, input devices (CD/LD transport, VCR, TV, etc.) as well as cables.

Symptom	Possible Cause(s)	Remedy
Mute on permanently.	No Lock LED.	Verify valid data at selected digital input.
	No digital source connected.	Verify that source is connected to the correct mapped jack.
No power or front panel lights and no sound.	Power cable is not inserted 100% into IEC connector.	Ensure that the AC cord is inserted completely into the Generation VIII and that the wall outlet is active.
	Circuit breaker is open.	Check the AC outlet circuit breaker and reset, if necessary, or contact your dealer.
	Generation VIII Fuse blown.	Check the fuse and, if necessary, replace ONLY with same type and rating.
No "LOCK" light.	Defective or intermittent cable.	Verify that the digital cable is not defective by checking the continuity, that both ends are firmly connected. If possible, try a different cable.
	Rear Panel input jack is not mapped to the currently selected INPUT button.	Go to the first SETUP page and set the appropriate input jack to the correct input.
	Defective source component.	Verify that the source component is functioning correctly and outputting valid digital data.
	Source component improperly connected.	Ensure that the output cable from the source component is connected to its active digital output.
No audio output.	No Lock LED.	Verify valid data at selected input.
	Mute is active	Ensure that the word MUTE is not showing in the top right of the display.
Distortion from analog input.	Clipping.	Adjust analog output level of the analog source device.
Sound present and Lock light on, but no display. Error message in display	Display level is set to off.	Press front panel DISPLAY button.
		Contact your dealer.

Table 3 – Troubleshooting Guide

Appendix B Wiring Diagrams

This section provides a sample illustration of various input and output wiring schemes. Before making any connections, please turn off ALL devices. Unplug those that do not have a main power switch. To avoid audible distortion and/or overall signal degradation, do not use standard audio cables for digital audio or video signals. It is recommended that all cables, including speaker cables be kept as short as possible for best sound quality.

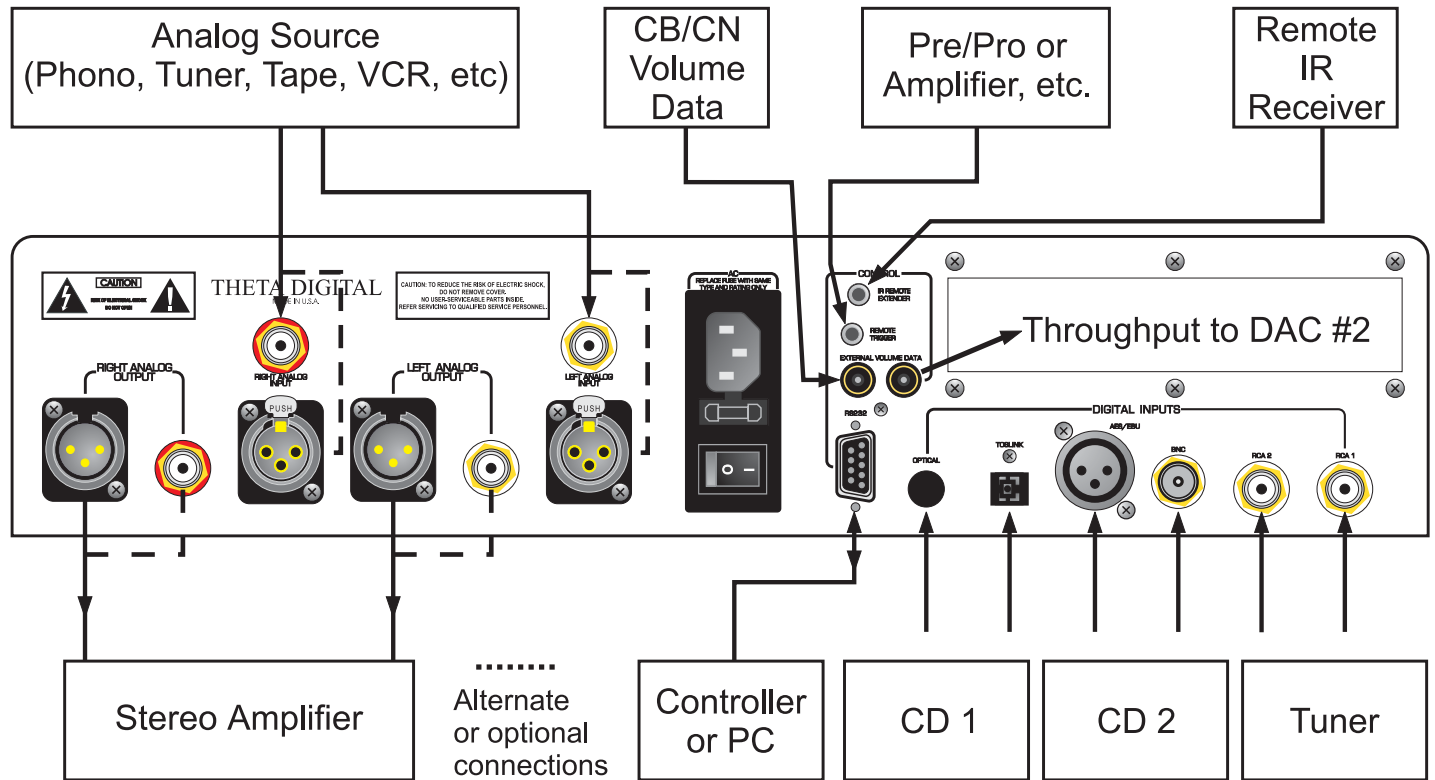

Figure 19 - Examples of Typical In and Out Connections

Note: If using an analog input jack for a phono input, an RIAA pre amp is required first.

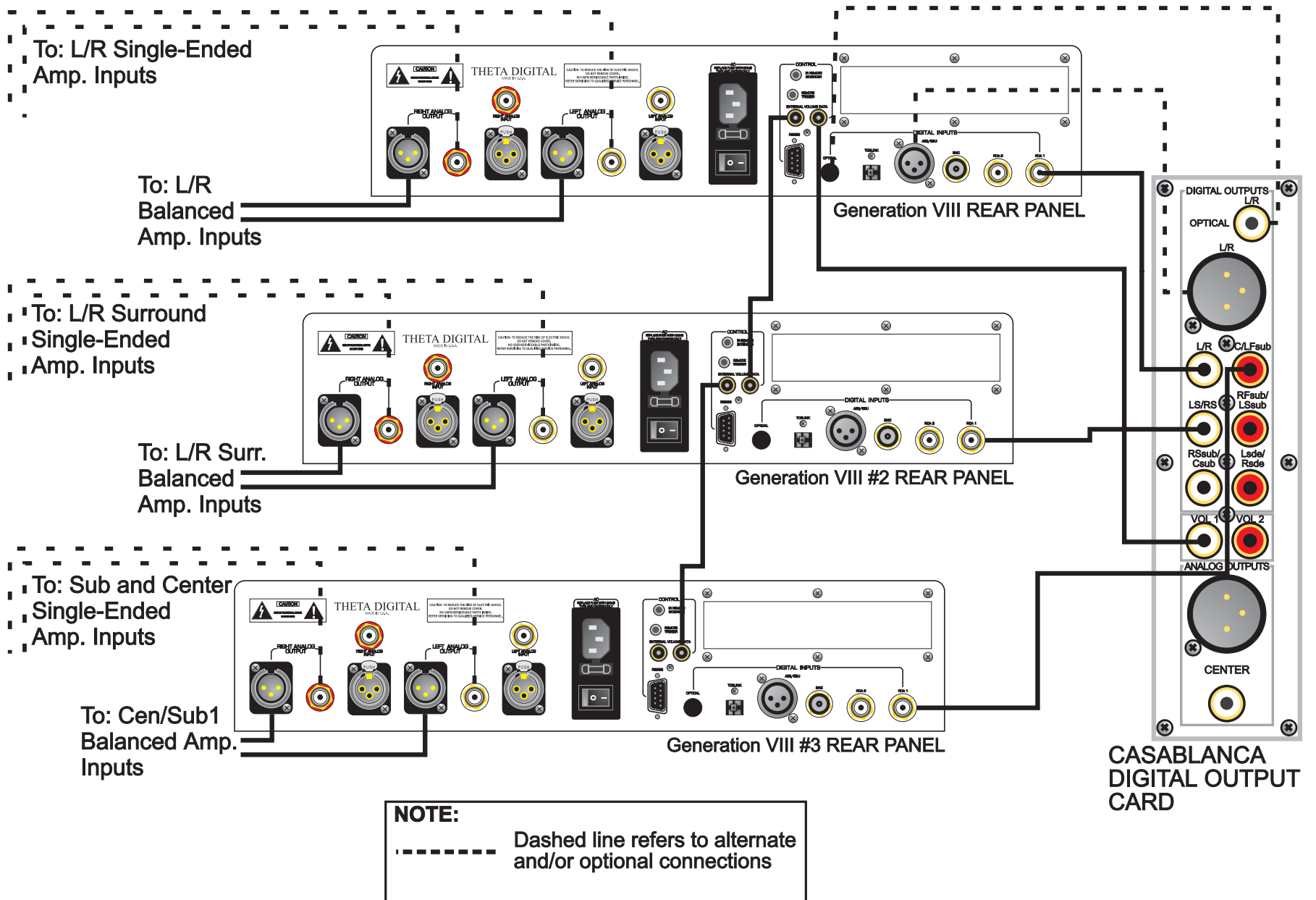

Figure 20 - Example of Connections to/from a Casablanca II Digital Out Card

Appendix C Remote Extender Jack Technical Description and Protocol

The remote extender jack on the Generation VIII rear panel serves as a direct electrical pathway to the input section of the main microcontroller. Using this jack eliminates the need to attach an IR transmitting device to the front panel IR receiver. This input requires a demodulated signal. **

Remote system: Phillips RC5

System address: 13 hex (00001101 binary) (5 bit system address)

6 bit button code:

Button	Code (hex)	Decimal	Code (binary)
1	1	1	0000001
2	2	2	0000010
3	3	3	0000011
4	4	4	0000100
5	5	5	0000101
STANDBY	C	12	0000111
MUTE	D	13	0001000
SETUP	E	14	0001110
DISPLAY	F	15	0001111
LEVEL UP	10	16	0010000
LEVEL DOWN	11	17	0010001
LEVEL RIGHT	20	32	0010000
LEVEL LEFT	21	33	0010001
PHASE	A	10	00001010
Discrete ON	23	35	00100011
Discrete OFF	24	36	00100100

Electrical Requirements:

Jack: 3.5mm stereo mini-phone

Tip: 12v current limited dc supply from Generation VIII (for phantom power)

Ring: Signal, 0-5 v peak-to-peak. (Is pulled high in Generation VIII)

Sleeve: Ground

* * *

** There are companies who manufacture units that strip the IR carrier from a signal. One such company is Xantech, who makes the model 794-10. If this unit is used, a series of dipswitches need to be set on it. These settings are as follows:

(from switch 1 to 10)

1 0 1 1 0 0 0 1 0 1

where 1 = ON and 0 = OFF

Appendix D RS232 Protocol

RS232 Hardware Connections

RTS and CTS are not implemented in Generation VIII

DB9

Pin	I/O	Jumped
1 - DCD	0	Jumped
2 - Generation VIII sends on this pin	0	
3 - Generation VIII receives on this pin	1	
4 - DTR	1	
5 - GND		
6 - DSR	0	
7 - RTS	1	
8 - CTS	0	
9 - Ring	---	

CN2

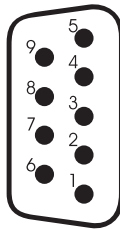

Rear panel view of DB9 connector
(From outside of unit).

These are the connector drawings only. The RS232 cable must be a regular RS232 or mouse extender cable that are wired pin for pin.

Generation VIII RS232 Control Details

RS232 settings are user definable in the Setup/RS232 menu, to accommodate interfacing with a wide range of control products.

Baud rate	4800, 9600, 19200, 38400, 57600 or 115200
Echo status	On-Off

Baud rate: Maximum number of bits per second. The duration of a single bit is equal to 1 / baud rate.

Echo status: Specifies whether the **STATUS** of each parameter shown in the protocol will automatically (**On**) be echoed back to the controller when there is any change, or whether no status information will be transmitted. Please refer to page 13 or information on changing these settings.

The parameters for RS232 communication will default to 8 bits, 1 stop bit and no parity. (Software flow control).

All values in this document are in Decimal.

All commands will follow the format:

<Header><Command Identifier><Argument 1><Argument 2><Argument 3>

where:

<Header> = <254><241>

<Command identifier> = <byte>

<Argument 1> = <byte>

<Argument 2> = <byte>

<Argument 3> = <byte>

Each command will be able to access the system configuration directly, eliminating the need to press any button on the Generation VIII's front panel.

Examples:

- 1) To put the Generation VIII into standby: Send 254, 241, 04, 14, 01, 00 (all values in decimal).
Where 254 and 241 are the header, 04 = Command_Do Action, 14 = Action_Power Main, 01 = put unit into standby, and 00 = filler (4 characters required).
- 2) To change to Input # 2: Send 254, 241, 01, 04, 00, 02
Where 254 and 241 are the header, 01 = Command_Variable_Change, 04 = Variable_Input_Selected, 00 = filler (4 characters required), and 02 = Input 2.

-OR-

254, 241, 04, 05, 02, 00
Where 254 and 241 are the header, 04 = Command_Do Action, 05 = Select Input, 02 = Input 2, and 00 = filler (4 characters required).
- 3) To increment the Master Volume: Send 254, 241, 04, 20, 00, 00
Where 254 and 241 are the header, 04 = Command_Do Action, 20 = Action_Variable Specified Increment, 00 = Variable_Master Volume, and 00 = filler (4 characters required)

Please note: All values below are in decimal.

Command	Description	Argument 1	Argument 1 Description	Argument 2	Argument 2 Desc	Argument 3	Arg 3 Desc
1	Variable Change	0-33	Variable number (See list)			0-86	new value
4	Do Action	5-21	Action number (See list)				See Action List
5	Get Variable Value	0-33	Variable number (See list)				
6	Return Status	0-1	Status level to return (See list)				
11	Simulate Keypress		Simulate Keypress number (See list)				
25	Execute Macro	2	Restore Factory Settings	4			
Action List	Action Name						
5	Select Input			1-5	Input number		
6	Mute			0-2	0=Toggle, 1=Mute, 2=Unmute		
8	Go to Menu			0-11	Menu # (See List)		
14	Power Main			0-2	0=Cycle Standby, 1=In Standby, 2=Out of Standby		
20	Variable Specified Increment					0-33	Variable # (See List)
21	Variable Specified Decrement					0-33	Variable # (See List)
Variable List	Variable Name	Range	Range Description				
0	Master Volume	0-86					
1	Volume Muted	0-1	0=Not muted, 1=Muted				
2	Display Brightness	0-4	0=Full, 1=3/4, 2=1/2, 3=1/4, 4=Off				
3	Balance	-7 to 7					
4	Input Selected	1-5					
5	Input Jack - Inp # 1	1-8	1=RCA1, 2=RCA2, 3=BNC, 4=XLR, 5=TOS, 6=Opt, 7=Ana Bal, 8=Ans S.E.				
6	Input Jack - Inp # 2	1-8	1=RCA1, 2=RCA2, 3=BNC, 4=XLR, 5=TOS, 6=Opt, 7=Ana Bal, 8=Ans S.E.				
7	Input Jack - Inp # 3	1-8	1=RCA1, 2=RCA2, 3=BNC, 4=XLR, 5=TOS, 6=Opt, 7=Ana Bal, 8=Ans S.E.				
8	Input Jack - Inp # 4	1-8	1=RCA1, 2=RCA2, 3=BNC, 4=XLR, 5=TOS, 6=Opt, 7=Ana Bal, 8=Ans S.E.				
9	Input Jack - Inp # 5	1-8	1=RCA1, 2=RCA2, 3=BNC, 4=XLR, 5=TOS, 6=Opt, 7=Ana Bal, 8=Ans S.E.				
10	Input Name - Inp # 1	0-19	0=number, 1=RCA1, 2=RCA2, 3=BNC, 4=XLR, 5=TOS, 6=Opti, 7=Abal, 8=A Se, 9=CD, 10=CD1, 11=CD2, 12=DVD, 13=DVD1, 14=DVD2, 15=Phon, 16=Tune, 17=AM, 18=FM, 19=TV				
11	Input Name - Inp # 2	0-19	0=number, 1=RCA1, 2=RCA2, 3=BNC, 4=XLR, 5=TOS, 6=Opti, 7=Abal, 8=A Se, 9=CD, 10=CD1, 11=CD2, 12=DVD, 13=DVD1, 14=DVD2, 15=Phon, 16=Tune, 17=AM, 18=FM,				

			19=TV				
12	Input Name - Inp # 3	0-19	0=number, 1=RCA1, 2=RCA2, 3=BNC, 4=XLR, 5=TOS, 6=Opti, 7=Abal, 8=A Se, 9=CD, 10=CD1, 11=CD2, 12=DVD, 13=DVD1, 14=DVD2, 15=Phon, 16=Tune, 17=AM, 18=FM, 19=TV				
13	Input Name - Inp # 4	0-19	0=number, 1=RCA1, 2=RCA2, 3=BNC, 4=XLR, 5=TOS, 6=Opti, 7=Abal, 8=A Se, 9=CD, 10=CD1, 11=CD2, 12=DVD, 13=DVD1, 14=DVD2, 15=Phon, 16=Tune, 17=AM, 18=FM, 19=TV				
14	Input Name - Inp # 5	0-19	0=number, 1=RCA1, 2=RCA2, 3=BNC, 4=XLR, 5=TOS, 6=Opti, 7=Abal, 8=A Se, 9=CD, 10=CD1, 11=CD2, 12=DVD, 13=DVD1, 14=DVD2, 15=Phon, 16=Tune, 17=AM, 18=FM, 19=TV				
15	Clock Type - Inp # 1	0-1	0=Jitter Jail, 1=Reclock				
16	Clock Type - Inp # 2	0-1	0=Jitter Jail, 1=Reclock				
17	Clock Type - Inp # 3	0-1	0=Jitter Jail, 1=Reclock				
18	Clock Type - Inp # 4	0-1	0=Jitter Jail, 1=Reclock				
19	Clock Type - Inp # 5	0-1	0=Jitter Jail, 1=Reclock				
20	Phase - Inp # 1	0-1	0="-", 1="+"				
21	Phase - Inp # 2	0-1	0="-", 1="+"				
22	Phase - Inp # 3	0-1	0="-", 1="+"				
23	Phase - Inp # 4	0-1	0="-", 1="+"				
24	Phase - Inp # 5	0-1	0="-", 1="+"				
25	Burn In	0-1	0=Off, 1=On				
26	Remote Trigger	0-3	0=Out-DC, 1=Out-Pulse, 2=Receive-DC, 3=Receive-Pulse				
27	Pulse Duration	0-4	0=50, 1=100, 2=150, 3=200, 4=250				
28	Baud Rate	0-5	0=4800, 1=9600, 2=19200, 3=38400, 4=57600, 5=115200				
29	Echo Status	0-1	0=No, 1=Yes				
30	IR Source	0-2	0=Front Panel, 1=Rear Jack, 2=None				
31	Ext Volume Receive	0-6	0=Left/Right, 1=Center/Sub, 2=L/R Surr, 3=Ch 7/8, 4=Ch 9/10, 5=Ch 11/12, 6=None				
32	Screensaver Time	1-60	Time in minutes				
33	Initial Volume	0-40	0=Level 0, 1=Level 1, etc.				
Menu List	Menu Name						
0	Standby						
1	Main						
2	Setup Inputs						
3	Setup Clocking						

4	Setup Burn In						
5	Setup Trigger						
6	Setup RS232						
7	Setup IR						
8	Setup Ext Volume						
9	Setup Screensaver						
10	Setup Serial/Version						
11	Edit Balance						
Status Returned							
Byte #	Description	Value					
1	Input	1-5					
2	Jack	1-8					
3	Volume	0-86					
4	Standby	0-1	0=standby, 1=not in standby				
5	Lock	0-1	0=not locked, 1=locked				
6							
6	Sample Rate	0-7	0=32K, 1=44K, 2=48K, 4=88K, 5=96K, 6=176K, 7=192K				
7	Variable 0						
8	Variable 1						
9	Variable 2						
10	Variable 3						
11	Variable 4						
12	Variable 5						
...	Variable ...						
40	Variable 33						
Simulate Keypress List							
Key	Value						
1-5	1-5						
Mute	8						
Setup	11						
Display	13						
Standby	14						
Level up	15						
Level down	16						
Level Left	19						
Level Right	20						
Phase	21						
Discrete Off	25						
Discrete On	26						

Appendix E Specifications

Digital Input Section (32KHz, 44.1KHz, 48KHz, 88.2KHz, 96KHz):

Main digital input board:

Inputs: 6: 3 coaxial (2 RCA and 1 BNC), 1 AES/EBU (XLR), 2 optical (1 TosLink, 1 open for optional AT&T).

Analog Input Section:

Inputs: 1 stereo pair on single-ended RCA jacks, 1 stereo pair on balanced XLR jacks.
Input Level: Single-Ended: DC to 10VRMS. Balanced: DC to 20VRMS
Input Impedance: 10 K Ω .
Frequency response: DC - 20KHz, +/-2dB
THD+Noise: <0.0005% @3VRMS in and out, balanced.
Dynamic Range: 125dB ref 18VRMS Bal
Signal to Noise Ratio: 125dB ref 18VRMS Bal

Processing (DSP) Section:

All DSP processing is 24bit with 56 bit accumulator.

Analog Audio Outputs:

2 balanced XLR (L/R) and 2 Single-Ended RCA jacks.

Balanced Output Specifications:

Output Impedance: 25 Ohms.
Maximum Output Level: 18 Vrms balanced (6.4VRMS balanced if Fixed Volume option installed).
Frequency Response: 20 Hz-20 kHz, \pm 0.01 dB, Ref. 1KHz.
THD+Noise: Less than 0.0012% @ 1KHz, maximum output level.
Dynamic Range: >115dB minimum, 20KHz bandwidth, Ref. 1KHz, A-weighted.
Signal to Noise Ratio: >115dB typical, idle channel, A-weighted.
Crosstalk: >140dB.

Single-Ended Output Specifications:

Output Impedance: 12 Ohms
Maximum Output Level: 9 Vrms (3.2 VRMS if Fixed Volume option installed).
Frequency Response: 20 Hz-20 kHz, \pm 0.01 dB, Ref. 1KHz.
THD+Noise: Less than 0.0035% @ 1KHz, maximum output level.
Dynamic Range: >112dB minimum, 20KHz bandwidth, Ref. 1KHz, A-weighted.
Signal to Noise Ratio: >112 typical, idle channel, A-weighted.
Crosstalk: >140dB.

D/A Conversion: 24-bit Ladder (8x oversampling). 2 DACs per channel for true differential operation.

Volume Control: Theta proprietary switched resistor network in the analog domain.

Digital Filter: 8x oversampling Theta proprietary FIR filter running on Motorola 56362 DSP.

Control Section:

- RS232: Complete ability to control and read status of every operational parameter of unit.
- IR Receiver: 3.5mm stereo phone jack (rear panel), unmodulated.
- IR Receiver: Front panel IR window for hand-held remote control.
- Remote Trigger: One 3.5mm mono phone jack: +12VDC triggered (Can be set to Pulse or Continuous DC), pulse time variable from 50 to 250 mSec. Trigger jack can be set as an input (receiver) or output (transmitter).
- External Volume Data: Receives digital volume information from Theta Casablanca/Casa Nova.

Power Requirements: 117 VAC, 50-60 Hz, 50 watts maximum, with all options installed.
Fuse @ 100 & 110V = 630mA, Fuse @ 220V = 3/8A.

Dimensions: 17 5/8" W x 5" H x 17 3/4" D (448 x 127 x 451 mm)

Weight: 29 Lbs (10.8 Kg) Stand alone, 35 Lbs (13.1 Kg) Boxed with accessories

Environment: Operating Temperature: 32 to 95 F (0 to 35 C)
Storage Temperature: -22 to 167 F (-30 to 75 C)
Relative Humidity: 95% maximum without condensation

Remote Control: 1 hand-held, battery powered control unit uses 2 AAA batteries.

Specifications subject to change without prior notice.

90 DAY LIMITED WARRANTY TERMS AND CONDITIONS
(5 Year optional extended service contract)

WARRANTY INFORMATION

1. Theta Digital Corporation, henceforth referred to as Theta, warrants the product designated herein to be free of manufacturing defects in material and workmanship, subject to the conditions set forth herein, for a period of 90 days from the date of purchase by the original purchaser, henceforth referred to as purchaser. If the purchaser registers the unit with Theta by mailing in the warranty card, together with a copy of the bill of sale, within 14 days of the date of purchase, said purchaser will be registered for an extended service contract. The extended service contract extends the 90 days to a period of 5 years from the date of purchase by the original purchaser or no later than 7 years from the date of shipment to the authorized Theta dealer, whichever comes first.
2. **CONDITIONS**

This warranty is subject to the following conditions and limitations. The warranty is void and inapplicable if the product has been used or handled other than in accordance with the instructions in the owner's manual, abused or misused, damaged by accident or neglect or in being transported, or if the defect is due to the product being repaired or tampered with or modified by anyone other than Theta or an authorized Theta repair center. In the unlikely event that the unit requires service, contact Theta for an RA (Return Authorization) number. The product must be packed and returned to Theta or an authorized Theta repair center by the customer at his or her sole expense. Theta will pay return freight of its choice. A returned product must be accompanied by a written description of the defect, a photocopy of the original purchase receipt, and a daytime phone number where the owner can be reached. The unaltered receipt must clearly list model and serial number, the date of purchase, the name and address of the purchaser and authorized dealer and the purchase price. Theta reserves the right to modify the design of any product without obligation to purchasers of previously manufactured products and to change the prices or specifications of any product without notice or obligation to any person. The warranty is valid only in the country in which the unit was purchased.
3. **REMEDY**

In the event the above product fails to meet the warranty, and the above conditions have been met, the purchaser's sole remedy under the limited warranty shall be to obtain an RA number and return the product to Theta or an authorized Theta repair center where the defect will be rectified without charge for parts or labor.
4. **LIMITED TO ORIGINAL PURCHASER**

This warranty is for the sole benefit of the original purchaser of the covered product and shall not be transferred to a subsequent purchaser of the product.
5. **DURATION OF WARRANTY**

This warranty expires 90 days after the date of original purchase. If Theta receives the completed warranty registration card within 14 days of original purchase, this period is extended to the fifth anniversary of the original date of purchase or no later than the seventh anniversary of the shipment to the authorized Theta dealer, whichever comes first.
6. **MISCELLANEOUS**

ANY IMPLIED WARRANTIES RELATING TO THE ABOVE PRODUCT SHALL BE LIMITED TO THE DURATION OF THIS WARRANTY. THE WARRANTY DOES NOT EXTEND TO ANY INCIDENTAL OR CONSEQUENTIAL COSTS OR DAMAGES TO THE PURCHASER. Some states do not allow limitations on how long an implied warranty lasts or an exclusion or limitation of incidental or consequential damages, so the above limitations or exclusions may not apply to you. This warranty gives you specific legal rights, and you may also have other rights which vary from state to state.
7. **WARRANTOR**

Inquiries regarding the above limited warranty may be sent to the following address:

THETA DIGITAL CORPORATION
5330 DERRY AVENUE, SUITE "R"
AGOURA HILLS, CA 91301

WARRANTY OUTSIDE THE USA

Theta has formal distribution in many of the countries of the free world. The Theta Importer in each country has contractually accepted the responsibility for product warranty. Warranty service should normally be obtained from the importing dealer or distributor through whom you obtained your product.

WARNINGS

1. To prevent fire or shock hazard, do not expose your Theta product to rain or moisture.
2. This unit contains voltages which can cause serious injury or death. Do not operate with covers removed. Refer all servicing to your authorized Theta dealer.
3. For continued protection against fire hazard, replace fuses only with the same type and rating of fuses as specified.