

# CINEMA™

u s e r ' s m a n u a l



c l s e l e c t r o s t a t i c

  
MARTIN LOGAN

# CONTENTS

---

<b>Contents</b> .....	<b>2</b>	<b>Home Theater</b> .....	<b>9</b>
<b>Installation in Brief</b> .....	<b>3</b>	<b>Electrostatic Advantages</b> .....	<b>10</b>
<b>Introduction</b> .....	<b>4</b>	<b>MartinLogan Exclusives</b> .....	<b>11</b>
<b>Operation</b> .....	<b>5</b>	Curvilinear Line Source	
AC Power Connection		Vapor Deposited Film	
Signal Connection		Transducer Integrity	
Break-In		<b>Electrostatic Loudspeaker History</b> .....	<b>12</b>
<b>Installation</b> .....	<b>6</b>	<b>Frequently Asked Questions</b> .....	<b>14</b>
Installation Options		<b>Troubleshooting</b> .....	<b>16</b>
Cinema Pad Installation		<b>General Information</b> .....	<b>17</b>
<b>Dispersion Interactions</b> .....	<b>7</b>	Specifications	
Controlled Horizontal Dispersion		Warranty and Registration	
Controlled Vertical Dispersion		Service	
Three Major Types of Dispersion		<b>Glossary of Audio Terms</b> .....	<b>18</b>

We know you are eager to hear your new Cinema center channel, so this section is provided to allow fast and easy set up. Once you have it operational, please take the time to read, in depth, the rest of the information in this manual. It will give you perspective on how to attain the greatest possible performance from this most exacting transducer.

If you should experience any difficulties in the setup or operation of your Cinema speaker, please refer to the Operation or Installation sections of this manual.

Should you encounter a persistent problem that cannot be resolved, please contact your authorized MartinLogan dealer. They will provide you with the appropriate technical analysis to alleviate the situation.



## WARNING!

- Hazardous voltages exist inside—do not remove cover
- Refer servicing to a qualified technician
- To prevent fire or shock hazard, do not expose this module to moisture
- Turn amplifier off and unplug speaker should any abnormal conditions occur
- Do not operate if there is any visual damage to the electrostatic panel element
- Do not over drive speaker beyond its rated power



The lightning bolt flash with arrowhead symbol, within an equilateral triangle, is intended to alert the user to the presence of uninsulated “dangerous voltage” within the product’s enclosure that may be of sufficient magnitude to constitute a risk of electric shock.



The exclamation point within an equilateral triangle is intended to alert the user to the presence of important operating and maintenance (servicing) instructions in the literature accompanying the appliance.

## Step 1: Unpacking

Remove your new Cinema speaker from the packing.

## Step 2: Placement

Place the Cinema directly between your front left and right speakers. This is a good place to start. Please see the Installation section (page 6) of this manual for more details.

## Step 3: Power Connection (AC) *(see warning)*

MartinLogan speakers require AC power to energize their electrostatic cells. Using the AC power cords provided, plug the Cinema in first to the AC power receptacle on the rear panel of the speaker, making sure that you have made a firm connection, and then to the wall outlet. Please see the Operations section (pages 5) of this manual for more details.

## Step 4: Signal Connection

Use the best speaker cables you can. Higher quality cables, available from your specialty dealer, are recommended and will give you superior performance. Spade connectors are suggested for optimum contact and ease of installation.

Attach your speaker cables to the Signal Input section on the rear panel. Be consistent when connecting speaker leads to the terminals on the back of the Cinema: take great care to assign the same color to the (+) terminal on both the speaker and the amplifier. Please see the Operations section (pages 5) of this manual for more details.

## Step 5: Listen and Enjoy

Now, you may turn on your system and enjoy!

# INTRODUCTION

---

## **Congratulations! You have invested in a new world of home cinema!**

The MartinLogan Cinema represents the culmination of an intensive, dedicated group research program directed toward establishing a world class reference monitor utilizing leading-edge technology, without compromising durability, reliability, craftsmanship or aesthetic design.

The advantages of MartinLogan hybrid technology will present themselves to you from the moment the movie begins. The box effect (a phenomenon similar to cupping your hand around your mouth when speaking) produced by dynamic midrange drivers is absent and the natural openness of the human voice comes through. Never before in home theatre has the midrange been so clear. Sounds float around the screen clearly defining the area from where they were created, not the area of the speaker that created them. This superior performance is made possible through the use of our proprietary curved electrostatic transducer. This is the same design technology that is used in the state-of-the-art MartinLogan Loudspeaker Systems.

The materials in your new Cinema speaker are of the highest quality and will provide years of enduring enjoyment and deepening respect. The cabinetry is constructed from the highest quality composite material for acoustical integrity and is finished with our attractive custom matte finish.

Through rigorous testing, the curvilinear electrostatic panel has proven itself to be one of the most durable and reliable transducers available today. Fabricated from a custom tool punched high-grade steel, the patented panel is then coated with a special polymer that is applied via a proprietary electrostatic deposition process. This panel assembly houses a membrane just 0.0005 of an inch thick. Ruggedly constructed and insulated, as much as 150 watts of continuous power has driven the Cinema's energized diaphragm into massive excursions with no deleterious effects.

The other sections of your User's Manual will explain in detail the operation of your Cinema speaker and the philosophy applied to their design. A clear understanding of your speakers will insure that you obtain maximum performance and pleasure from this most exacting transducer. It has been designed and constructed to give you years of trouble-free listening enjoyment.

## AC Power Connection

Because your MartinLogan Cinema uses an internal power supply to energize its electrostatic cells with high-voltage DC, it must be connected to an AC power source. For this reason it is provided with the proper IEC standard power cord. This cords should be firmly inserted into the AC power receptacles on the rear connection panel of the speaker, then to any convenient AC wall outlet. The Cinema integrates a signal sensing power supply which will switch off after a few minutes of no music signal, and requires less than two seconds to recharge the panels when a music signal is present.

Your Cinema speaker is wired for the power service supplied in the country of original consumer sale. The AC power rating applicable to a particular unit is specified both on the packing carton and on the serial number plate attached to the speaker.

If you remove your Cinema speaker from the country of original sale, be certain that AC power supplied in any subsequent location is suitable before connecting and operating the speakers. Substantially impaired performance or severe damage may occur to the Cinema speaker if operation is attempted from an incorrect AC power source.

 **WARNING!** The power cord should not be installed, removed, or left detached from the speaker while the other end is connected to an AC power source.

## Signal Connection

Use the best speaker cables you can. The length and type of speaker cable used in your system will have an audible effect. Under no circumstance should a wire of gauge higher (thinner) than #16 be used. In general, the longer the length used, the greater the necessity of a lower gauge, and the lower the gauge, the better the sound, with diminishing returns setting in around #8 to #12.

A variety of speaker cables are now available whose manufacturers claim better performance over standard heavy gauge wire. We have verified this in many cases, and the improvements available are often more noticeable than the differences between wires of different gauge. The effects of cables may be masked if the equipment is not of the highest quality.

We also recommend, if possible, that short runs of speaker cable connect the power amplifier and speaker and that high quality long interconnect cables be used to connect the preamplifier and power amplifier. This results in the power amplifiers being close to the speakers, which may be practically or cosmetically difficult, but if the length of the speaker cables can be reduced to a few meters, sonic advantages may be obtained.

Connections are done at the Signal Input section on the rear electronics panel of the Cinema (see figure 1). Use spade connectors for optimum contact. Make certain that all of your connections are tight.

Be consistent when connecting speaker leads to the terminals on the back of the Cinema: take great care to assign the same color to the (+) terminal on both the speaker and the amplifier.

 **WARNING!** Turn your amplifier off before making or breaking any signal connections!

## Break-In

When you first begin to play your Cinema speaker, it will sound a bit bass shy. This is due to the high-quality, long-life components used in our woofer. Our custom made, butyl surround woofer requires at least 30 hours of break-in at 90 dB (moderate listening levels) before any critical listening. The break-in requirements of the crossover components (and, to a lesser degree, the electrostatic transducer) are equal.

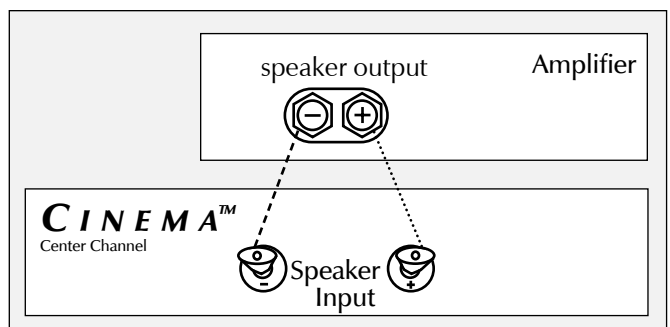

Figure 1. Speaker cable connection on rear panel of the Cinema.

# INSTALLATION

## Installation Options

### On the Television

If your television provides a wide, level and stable platform, the shielded Cinema can be placed directly on it (see figure 3). The Cinema is equipped with nonskid material underneath to prevent vibration and to keep it from scratching the top of your television. Please see the “Cinema Pad Installation” section below for more details.

### On the Wall

An optional adjustable mount is available allowing you to mount the Cinema on the wall or ceiling without locating a stud (see figure 4). Contact your dealer for details.

### On the Floor

Placing the Cinema on the floor may position it too low to blend with the front speakers. The use of a stand that positions the Cinema at the bottom of the screen may be a good solution (see figure 5). However, if placing the Cinema on the floor is the best arrangement for your system, the optional adjustable mount will allow for tilting towards the listening position. Contact your dealer for details

## Cinema Pad Installation

If not using the optional Cinema adjustable mount, we have provided protective pads to protect the surface the Cinema will be placed on. Follow the instructions below to properly adhere the pads to the bottom of the Cinema (see figure 2). To prevent slipping it is important that the Cinema be used on a level surface. If the Cinema is being used on a tilted surface we recommend use of the optional adjustable mount.

### Cinema Pad Installation Instructions:

1. Turn the Cinema upside down and set it on a soft towel.
2. Place the protective pads on the Cinema to determine their placement.
3. Remove white backing being careful not to peel the adhesive layer off.
4. Line up the holes in the pads with the holes in the bottom of the Cinema and carefully apply.

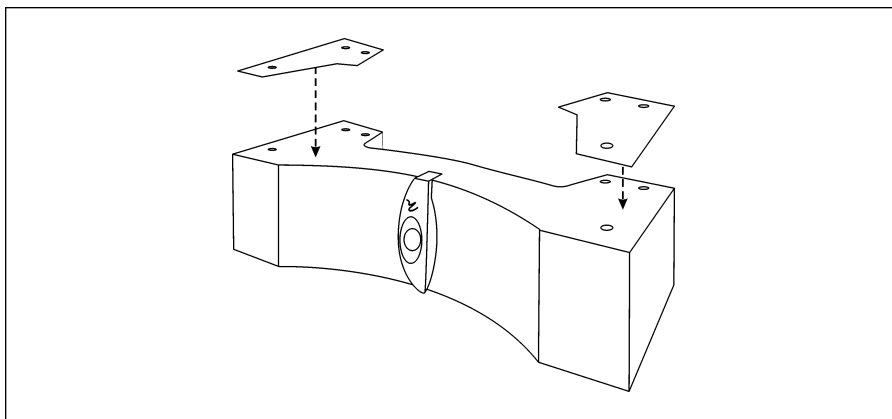

Figure 2. Installing the Cinema pads.

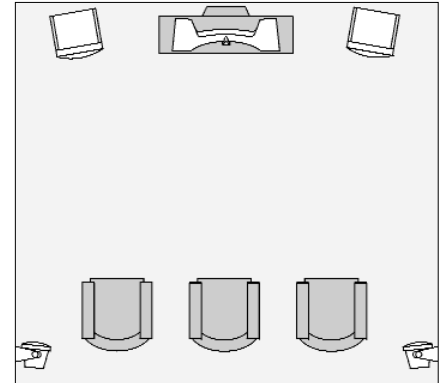

Figure 3. On the television

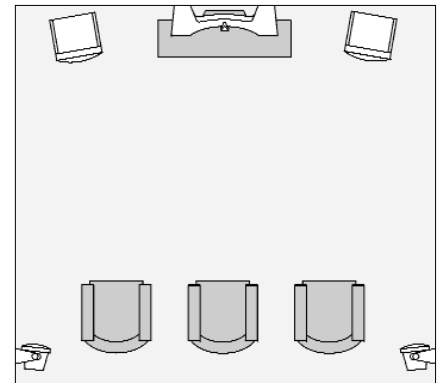

Figure 4. On the wall

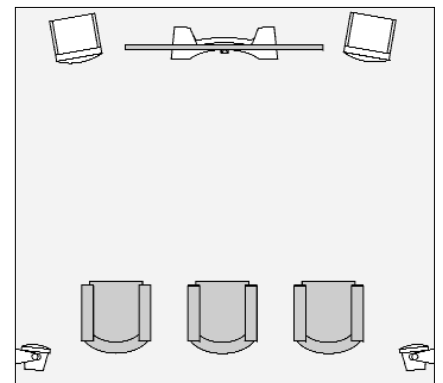

Figure 5. On the floor

## Controlled Horizontal Dispersion

The concave electrostatic panel launches a 30 degree dispersion pattern when viewed from above. The sound waves focus in front of the speaker and diverge much like a lens would cause light to focus and diverge. This horizontal dispersion field operates in the same manner as our traditional curvilinear line source (CLS) technology, giving you a choice of good seats for the performance while minimizing interaction with side walls (see figure 6).

## Controlled Vertical Dispersion

As you can see from the illustrations, your Cinema speaker projects a controlled dispersion pattern (See figure 7). This vertical dispersion profile minimizes interactions with the floor and the ceiling.

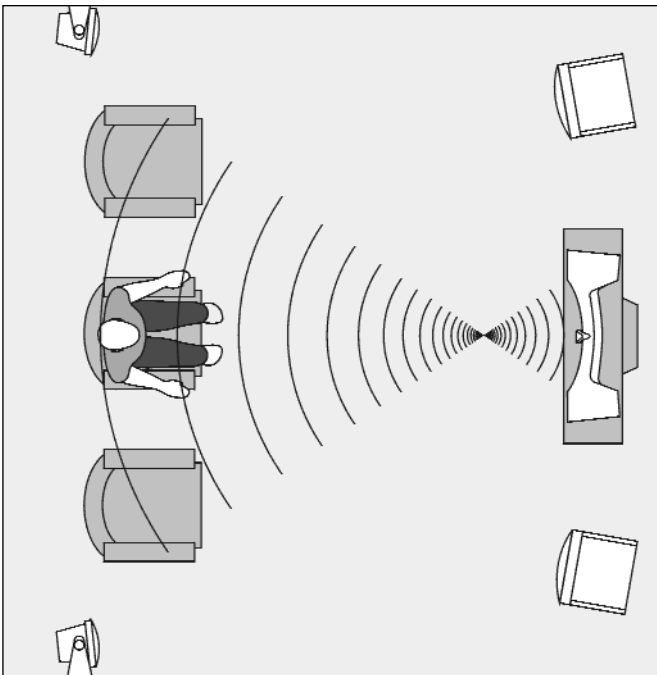

**Figure 6.** The MartinLogan Cinema delivers a 30 degree wave launch dispersion pattern distributed horizontally.

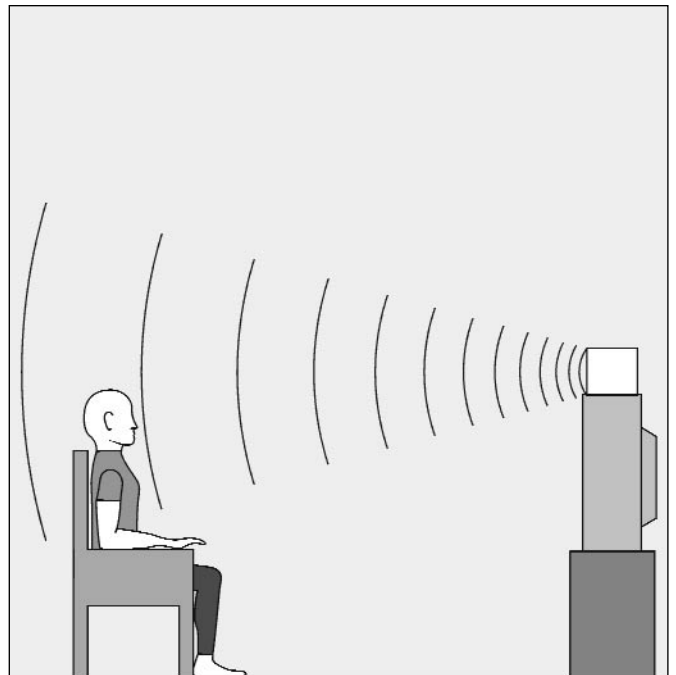

**Figure 7.** The MartinLogan Cinema vertical dispersion profile minimizes interactions with the floor and ceiling.

## Three Major Types of Dispersion

In the field of loudspeaker design, it is a known fact that as the sound wave becomes progressively smaller than the transducer producing it, the dispersion of that wave becomes more and more narrow, or directional. This fact occurs as long as the transducer is a flat surface. Large flat panel speakers exhibit venetian blind effects due to this phenomenon. This is why most manufacturers opt for small drivers (i.e. tweeters and midrange) to approximate what is known as a point source wave launch.

Historically, most attempts to achieve smooth dispersion from large flat panel transducers resulted in trade-offs. After exhaustive testing of these different solution attempts, we found an elegantly simple, yet very difficult to execute solution. By curving the radiating surface, we create the effect of a horizontal arc. This allows the engineers at MartinLogan to control the high frequency dispersion pattern of our transducers. That is why you see the gentle curve on our products.

**Figure 8–9.** As can be seen here, point source concepts invite a great deal of room interaction. While delivering good frequency response to a large listening audience, imaging is consequently confused and blurred.

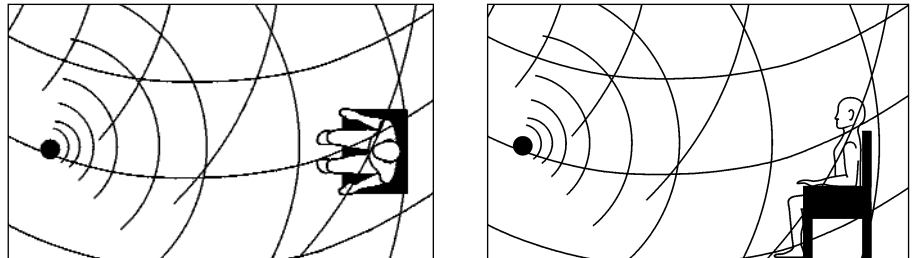

**Figure 10–11.** Even though they suffer from “venetian blind” effect, angled multiple panel speakers can deliver good imaging, but only to specific spots in the listening area.

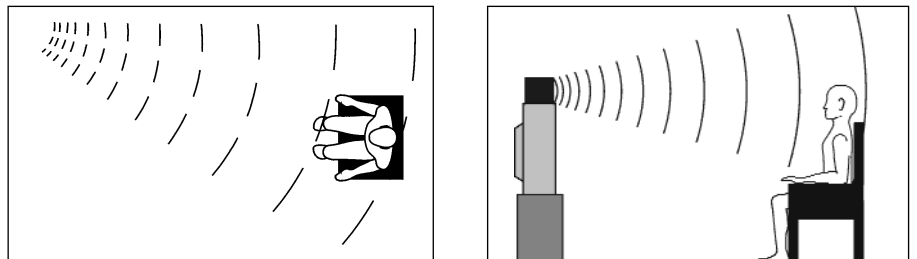

**Figure 11–12.** A controlled 30-degree cylindrical wave-front, which is a MartinLogan exclusive, offers optimal sound distribution with minimal room interaction. The result is solid imaging with a wide listening area.

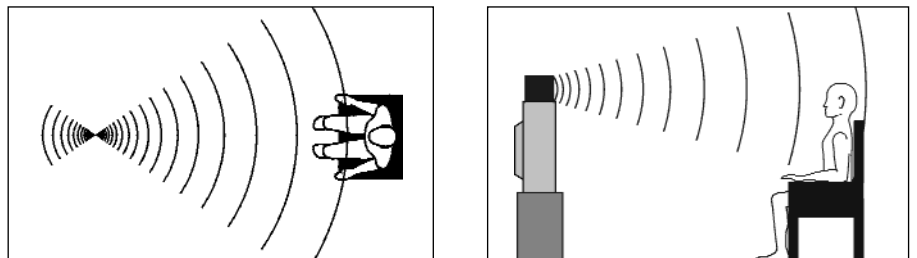



It had long been the practice of stereo buffs to connect their television to the stereo system. The advantage was the use of the larger speakers and more powerful amplifier of the stereo system. Even though the sound was greatly improved, it was still mono and limited by the broadcast signal.

In the late 1970's and early '80's two new home movie formats became widely available to the public: VCR and laser disc.

By 1985, both formats had developed into very high quality audio/video sources. In fact, the sonic performance of some video formats exceeded audio-only formats. Now, with theater quality sound available at home, the only element missing was the "surround sound" presentation found in movie houses.

Fortunately, "Dolby" and "DTS" encoded movies (which include almost all movies) have the same surround sound information encoded on home releases as the theater films. All that is required to retrieve this information is a decoder and additional speakers and amps to reproduce it.

Home theater is a complex purchase and we recommend that you consult your local MartinLogan dealer as they are well versed in this subject

Each piece of a surround system can be purchased separately. Take your time and buy quality. No one has ever complained that the movie was too real. The following list and descriptions will only give you a brief outline of the responsibilities and demands placed on each speaker.

### Front Left and Front Right

If these speakers will also be the same two used for your stereo playback then they should be of very high quality and able to play loud (over 102 dB) and reproduce bass below 80 Hz.

### Center Channel.

This is the most important speaker in a video system, as almost all of the dialogue and a large portion of the front speaker information is reproduced by the center channel. It is important that the center speaker be designed by the same manufacturer as the front speakers, and that it is recommended for use as a center speaker. This is not the place to cut corners.

### Surround Speakers.

We recommend that the surround speakers play down to 80 Hz or below. The surround speakers contain the information that makes it appear that planes are flying over your head. Some may suggest that this is the place to save money and purchase a small inexpensive speaker. If you choose to do so, be prepared to upgrade in the future as discrete six channel digital encoding becomes available and the demands on the surround speakers increase.

### Subwoofer.

With any good surround system you will need a high quality subwoofer (the .1, in a 5.1 channel surround system). Most movie soundtracks contain large amounts of bass information as part of the special effects. Good subwoofers will provide a foundation for the rest of the system.

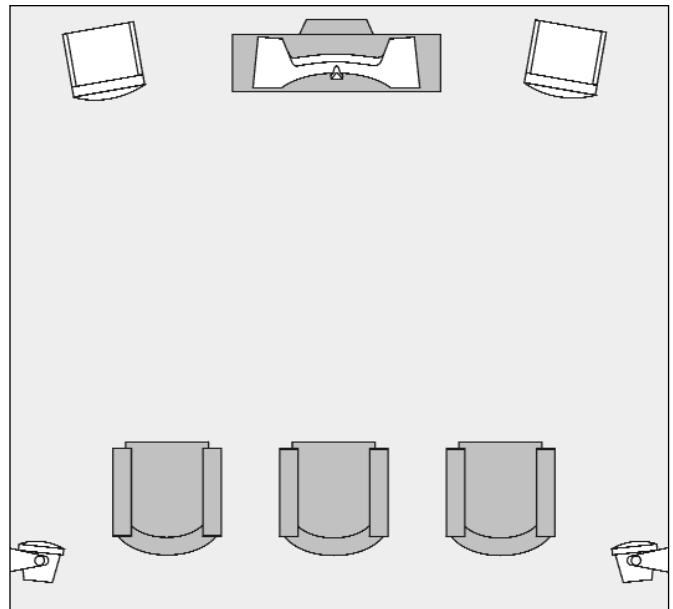

**Figure 13.** SL3 speakers as front channels, MartinLogan Cinema as the center channel, MartinLogan Scripts as side surround (effects) channels.

# ELECTROSTATIC ADVANTAGES

How can sound be reproduced by something that you are able to see through? Electrostatic energy makes this possible.

Where the world of traditional loudspeaker technology deals with cones, domes, diaphragms and ribbons that are moved with magnetism, the world of electrostatic loudspeakers deals with charged electrons attracting and repelling each other.

To fully understand the electrostatic concept, some background information will be helpful. Remember when you learned in a science or physics class that like charges repel each other and opposite charges attract each other? Well, this principle is the foundation of the electrostatic concept.

An electrostatic transducer consists of three pieces: the stators, the diaphragm and the spacers (See Figure 14). The diaphragm is what actually moves to excite the air and create music. The stator's job is to remain stationary, hence the word stator, and to provide a reference point for the moving diaphragm. The spacers provide the diaphragm with a fixed distance in which to move between the stators.

As your amplifier sends music signals to an electrostatic speaker, these signals are changed into two high-voltage signals that are equal in strength but opposite in polarity. These high voltage signals are then applied to the stators. The resulting electrostatic field, created by the opposing high voltage on the stators, works simultaneously with and against the diaphragm, consequently moving it back and forth, producing music. This technique is known as

push-pull operation and is a major contributor to the sonic purity of the electrostatic concept due to its exceptional linearity and low distortion.

Since the diaphragm of an electrostatic speaker is uniformly driven over its entire area, it can be extremely light and flexible. This allows it to be very responsive to transients, thus perfectly tracing the music signal. As a result, great delicacy, nuance and clarity is possible. When you look at the problems of traditional electromagnetic drivers, you can easily see why this is so beneficial. The cones and domes which are used in traditional electromagnetic drivers cannot be driven uniformly because of their design. Cones are driven only at the apex. Domes are driven at their perimeter. As a result, the rest of the cone or dome is just "along for the ride". The very concept of these drivers requires that the cone or dome be perfectly rigid, damped and massless. Unfortunately, these conditions are not available in our world today.

To make these cones and domes move, all electromagnetic drivers must use voice coils wound on formers, spider assemblies, and surrounds to keep the cone or dome in position (See Figure 15). These pieces, when combined with the high mass of the cone or dome materials used, make it an extremely complex unit with many weaknesses and potential for failure. These faults contribute to the high distortion products found in these drivers and is a tremendous disadvantage when you are trying to change motion as quickly and as accurately as a loudspeaker must (40,000 times per second!).

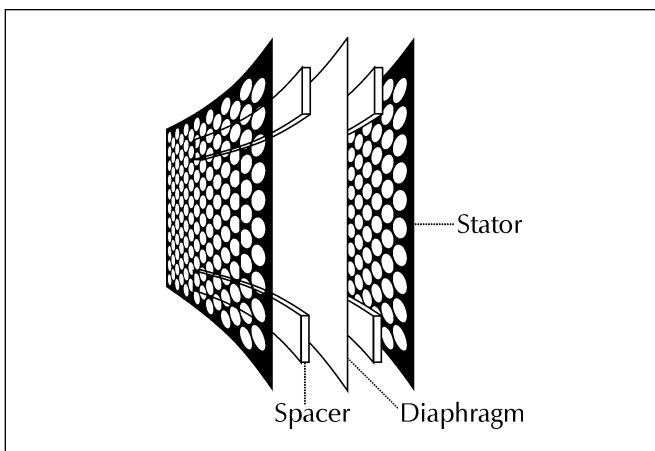

**Figure 14.** Cut away view of an electrostatic transducer. Notice the simplicity due to minimal parts usage.

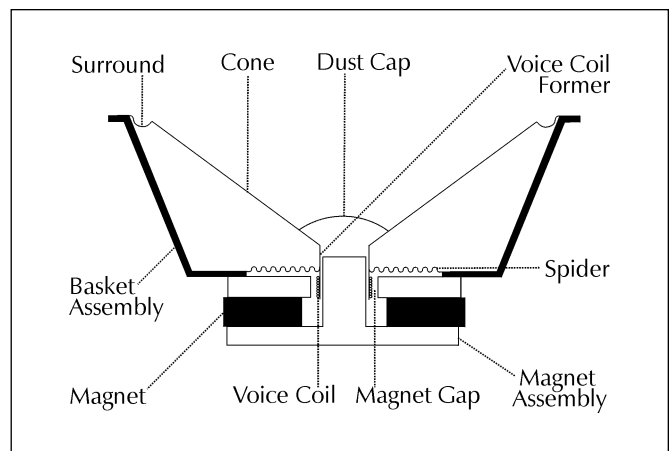

**Figure 15.** Cut away view of a typical moving coil driver. Notice the complexity due to the high number of parts.

## Curvilinear Line Source (CLS™)

Since the beginning of audio, achieving smooth dispersion has been a problem for all loudspeaker designers. Large panel transducers present even more of a challenge because the larger the panel, the more directional the dispersion pattern becomes.

Full range electrostats have long been one of the most problematic transducers because they attain their full range capabilities via a large surface area. It looked as if they were in direct conflict to smooth dispersion and almost every attempt to correct this resulted in either poor dispersion or a serious compromise in sound quality.

After extensive research, MartinLogan engineers discovered an elegantly simple solution to achieve a smooth pattern of dispersion without degrading sound quality. By curving the horizontal plane of the electrostatic transducer, a controlled horizontal dispersion pattern could be achieved, yet the purity of the almost massless electrostatic diaphragm remained uncompromised. After creating this technology, MartinLogan developed the production capability to bring it out of the laboratory and into the market place.

You will find this proprietary MartinLogan technology used in all of our products. It is one of the many reasons behind our reputation for high quality sound with practical usability. This is also why you see the unique “see through” cylindrical shape of all MartinLogan products.

## Vapor Deposited Film

The diaphragm material used in all MartinLogan speakers employs an extremely sophisticated conductive surface that has been vapor deposited on the polymer surface at an atomic level. A proprietary compound is vaporized then electrostatically driven into the surface of the polymer film in a vacuum chamber. This process allows an optically transparent surface adding no mass to the diaphragm that is extremely uniform in its surface resistivity characteristics. This uniform surface resistivity controls the electrostatic charge on the diaphragm surface and regulates its migration. As a result, no discharging or “arcing” can occur.

## Transducer Integrity

All MartinLogan transducers begin with two pieces of high-grade, cold rolled steel. These steel pieces are then custom perforated and insulated with a unique composite coating. This proprietary coating insulates the stator to three times its actual needed working voltage and gives the Cinema a wide margin of safe operation. In addition to the electrical insulation properties, this coating also provides the Cinema with a durable, attractive finish that dampens the steel to prevent ringing. These pieces are then sandwiched with our exclusive vapor deposited diaphragm and spacers into a curved geometry, and bonded together with aerospace adhesives whose strength exceeds that of welding.

The result of these advanced technologies is a transducer that is attractive, durable, highly rigid, well dampened, and neutral.

# ELECTROSTATIC LOUDSPEAKER HISTORY

---

In the late 1800s, any loudspeaker was considered exotic. Today, most of us take the wonders of sound reproduction for granted.

It was 1880 before Thomas Edison had invented the first phonograph. This was a horn-loaded diaphragm that was excited by a playback stylus. In 1898, Sir Oliver Lodge invented a cone loudspeaker, which he referred to as a “bellowing telephone”, that was very similar to the conventional cone loudspeaker drivers that we know today. However, Lodge had no intention for his device to reproduce music because in 1898 there was no way to amplify an electrical signal! As a result, his speaker had nothing to offer over the acoustical gramophones of the period. It was not until 1906 that Dr. Lee DeForrest invented the triode vacuum tube. Before this, an electrical signal could not be amplified. The loudspeaker, as we know it today, should have ensued then, but it did not. Amazingly, it was almost twenty years before this would occur.

In 1921, the electrically cut phonograph record became a reality. This method of recording was far superior to the mechanically cut record and possessed almost 30 dB of dynamic range. The acoustical gramophone couldn't begin to reproduce all of the information on this new disc. As a result, further developments in loudspeakers were needed to cope with this amazing new recording medium.

By 1923, Bell Telephone Laboratories made the decision to develop a complete musical playback system consisting of an electronic phonograph and a loudspeaker to take advantage of the new recording medium. Bell Labs assigned the project to two young engineers, C.W. Rice and E.W. Kellogg.

Rice and Kellogg had a well equipped laboratory at their disposal. This lab possessed a vacuum tube amplifier with an unheard of 200 watts, a large selection of the new electrically cut phonograph, records and a variety of loudspeaker prototypes that Bell Labs had been collecting over the past decade. Among these were Lodge's cone, a speaker that used compressed air, a corona discharge (plasma) speaker, and an electrostatic speaker.

After a short time, Rice and Kellogg had narrowed the field of “contestants” down to the cone and the electrostat.

The outcome would dictate the way that future generations would refer to loudspeakers as being either “conventional”, or “exotic”.

Bell Laboratory's electrostat was something to behold. This enormous bipolar speaker was as big as a door. The diaphragm, which was beginning to rot, was made of a pig intestine that was covered with fine gold leaf to conduct the audio signal.

When Rice and Kellogg began playing the new electrically cut records through the electrostat, they were shocked and impressed. The electrostat performed splendidly. They had never heard instrumental timbres reproduced with such realism. This system sounded like real music rather than the honking, squawking rendition of the acoustic gramophone. Immediately, they knew they were on to something big. The acoustic gramophone was destined to become obsolete.

Due to Rice and Kellogg's enthusiasm, they devoted a considerable amount of time researching the electrostatic design. However, they soon encountered the same difficulties that even present designers face; planar speakers require a very large surface area to reproduce the lower frequencies of the audio spectrum. Because the management at Bell Labs considered large speakers unacceptable, Rice and Kellogg's work on electrostatics would never be put to use for a commercial product. Reluctantly, they advised the Bell management to go with the cone. For the next thirty years, the electrostatic design lay dormant.

During the Great Depression of the 1930s, consumer audio almost died. The new electrically amplified loudspeaker never gained acceptance, as most people continued to use their old Victrola-style acoustic gramophones. Prior to the end of World War II, consumer audio saw little, if any, progress. However, during the late 1940s, audio experienced a great rebirth. Suddenly there was tremendous interest in audio products, and with that, a great demand for improved audio components. No sooner had the cone become established than it was challenged by products developed during this new rebirth.

## **Rice and Kellogg had narrowed the field of “contestants” down to the cone and the electrostat.**

---

In 1947, Arthur Janszen, a young Naval engineer, took part in a research project for the Navy. The Navy was interested in developing a better instrument for testing microphone arrays. The test instrument needed an extremely accurate speaker, but Janszen found that the cone speakers of the period were too nonlinear in phase and amplitude response to meet his criteria. Janszen believed that electrostats were inherently more linear than cones, so he built a model using a thin plastic diaphragm treated with a conductive coating. This model confirmed Janszen's beliefs, for it exhibited remarkable phase and amplitude linearity.

Janszen was so excited with the results that he continued research on the electrostatic speaker on his own time. He soon thought of insulating the stators to prevent the destructive effects of arcing. By 1952, he had an electrostatic tweeter element ready for commercial production. This new tweeter soon created a sensation among American audio hobbyists. Since Janszen's tweeter element was limited to high frequency reproduction, it often found itself used in conjunction with woofers, most notably, woofers from Acoustic Research. These systems were highly regarded by all audio enthusiasts.

As good as these systems were, they would soon be surpassed by another electrostatic speaker.

In 1955, Peter Walker published three articles on electrostatic loudspeaker design in *Wireless World*, a British electronics magazine. In these articles, Walker demonstrated the benefits of the electrostatic loudspeaker. He explained that electrostatics permit the use of diaphragms that are low in mass, large in area, and uniformly driven over their surfaces by electrostatic forces. Due to these characteristics, electrostats have the inherent ability to produce a wide bandwidth, flat frequency response with distortion products being no greater than the electronics driving them.

By 1956, Walker backed up his articles by introducing a consumer product, the now famous Quad ESL. This speaker immediately set a standard of performance for the audio industry due to its incredible accuracy. However, in actual use, the Quad had a few problems. It could not be played very loud, it had poor bass performance, it presented a difficult load that some amplifiers did not like, its dispersion was very directional, and its power handling was limited

to around 70 watts. As a result, many people continued to use box speakers with cones.

In the early 1960s Arthur Janszen joined forces with the KLH loudspeaker company, and together they introduced the KLH 9. Due to the large size of the KLH 9, it did not have as many limitations as the Quad. The KLH 9 could play markedly louder and lower in frequency than the Quad ESL. Thus a rivalry was born.

**These developments allow the consumer to own the highest performance loudspeaker products ever built.**

Janszen continued to develop electrostatic designs. He was instrumental in the design of the Koss Model One, the Acoustech, and the Dennesen speakers. Roger West, the chief designer of the JansZen Corporation became the president of Sound Lab.

When JansZen Corporation was sold, the RTR loudspeaker company bought half of the production tooling. This tooling was used to make the electrostatic panels for the Servostatic, a hybrid electrostatic system that was Infinity's first speaker product. Other companies soon followed; each with their own unique applications of the technology. These include Acostat, Audiostatic, Beverage, Dayton Wright, Sound Lab, and Stax, to name a few.

Electrostatic speakers have progressed and prospered because they actually do what Peter Walker claimed they would. The limitations and problems experienced in the past were not inherent to the electrostatic concept. They were related to the applications of these concepts.

Today, these limitations have been addressed. Advancements in materials due to the U.S. space program give designers the ability to harness the superiority of the electrostatic principle. Today's electrostats use advanced insulation techniques or provide protection circuitry. The poor dispersion properties of early models have been addressed by using delay lines, acoustical lenses, multiple panel arrays or, as in our own products, by curving the diaphragm. Power handling and sensitivity have also been increased.

These developments allow the consumer the opportunity to own the highest performance loudspeaker products ever built. It's too bad Rice and Kellogg were never able to see just how far the technology would be taken.

## FREQUENTLY ASKED QUESTIONS

---

### **How do I clean my speakers?**

Just use a dust free cloth or a soft brush to remove the dust from your speakers. We recommend a specialty cloth (available through the XStatic shop at [www.martinlogan.com](http://www.martinlogan.com)) that cleans your speakers better than anything else we have ever tried. **Do not spray any kind of cleaning agent on or in close proximity to the electrostatic element.**

### **What is the advantage of ESL?**

Since the polyester film diaphragm is uniformly driven over its entire surface—unlike a tweeter that is only driven at its edges—it is the only technology that can be made large enough to play bass, yet is still light enough for high frequencies. This unique property allows for the elimination of high frequency crossover points and their associated distortions.

### **What size of an amplifier should I use?**

We recommend an amplifier with 100 to 200 watts per channel for most applications. Probably less would be adequate for our smaller hybrids or when used in home theater where a subwoofer is employed. Our hybrid designs will perform well with either a tube or transistorized amplifier, and will reveal the sonic character of either type. However, it is important that the amplifier be stable operating into varying impedance loads: a stable amplifier will be able to deliver twice its rated wattage into 4 Ohms and should again double into 2 Ohms.

### **Could you suggest a list of suitable electronics and cables that would be ideal for MartinLogan speakers?**

The area of electronics and cable choice is probably the most common type of question that we receive. It is also the most subjective. We have repeatedly found that brands that work well in one setup will drive someone else nuts in another. We use many brands with great success. Again, we have no favorites; we use electronics and cables quite interchangeably. We would suggest listening to a number of brands—and above all else, trust your ears. Dealers are always the best source for information when purchasing additional audio equipment.

### **Is there likely to be any interaction between my speakers and the television in my Audio/Video system?**

Actually, there is less interaction between a television and an electrostatic speaker than between a television and a conventional system. In the case of our center channel speakers, they are fully shielded and can be placed directly on or near your television.

### **Will my electric bill go 'sky high' by leaving my speakers plugged in all the time?**

No. A pair of MartinLogans will draw about 5 watts maximum. There is some circuitry to turn off the static charge when not in use; however, the actual consumption will remain close to the same. The primary purpose of the sensing circuitry is to prevent dust collection on the electrostatic element.

### **If the diaphragm is punctured with a pencil, stick, or similar item, how extensive would the damage to the speaker be?**

Our research department has literally punctured hundreds of holes in a diaphragm, neither affecting the quality of the sound nor causing the diaphragm to rip. However, you will be able to see the actual puncture and it can be a physical nuisance. If this is the case, replacing the electrostatic transducer will be the only solution.

### **Will exposure to sunlight affect the life or performance of my speakers?**

We recommend that you not place any loudspeaker in direct sunlight, as the ultraviolet (UV) rays from the sun can cause deterioration of grill cloth, speaker cones, etc. Small exposures to UV will not cause a problem. In general, the filtering of UV rays through glass will greatly reduce the negative effects on the electrostatic membrane itself.

---

**Will excessive smoke or dust cause any problems with my electrostatic speakers?**

Exposure to excessive contaminants such as smoke or dust may potentially affect the performance of the electrostatic membrane, and may cause discoloration of the diaphragm membrane. When not in use for extended periods, you should unplug the speakers and cover them with the plastic bags in which the speakers were originally packed.

It is a good idea to vacuum the electrostatic portion of each speaker once or twice a year. This will be most effective if the speaker has been unplugged for six hours or overnight. You need not worry about the vacuum pressure damaging the "delicate" membrane. It is extraordinarily durable.

**A problem has recently developed with my MartinLogan speakers. The right speaker seems to be hissing even when the amplifier and such are not connected. I was wondering if this sounds like any problem you have encountered previously and have a simple solution for or might it be something which will need to be looked into more carefully.**

Your speakers are dusty. The electrostatic charge on the element has attracted some airborne dust or pollen. First unplug the speakers for six hours or overnight. This will allow the charge to dissipate. Now vacuum the front of the panel with a very strong vacuum. Don't worry about damaging the membrane. You won't. This should take care of the hiss.

By the way, since 1993, all of our speakers have been built with a charging circuit board that only charges the electrostatic element when music plays. At other times they are not charged, and cannot collect dust. You can get the same benefit by simply unplugging them whenever they are not in use. An easy way to do that is with a power strip that has a switch.

**Could my children, pets, or myself be shocked by the high-voltage present in the electrostatic panel?**

No. High voltage with low current is not dangerous. As a matter of fact, the voltage in our speakers is 10 times less than the static electricity that builds up on the surface of your television screen.

**How do MartinLogan speakers hold up over a long term in the humidity of tropical climates?**

We should tell you that MartinLogan indeed has a very substantial number of customers in tropical regions of the world. Our speakers have been serving them nicely for many years. This concern may have come from our earlier design of speakers, which were charged continuously. Since 1993, all of our speakers have been designed so that they only charge the panel while music is being played. This improvement has made a tremendous difference in the consistent performance of our product. There may be a little more maintenance involved in humid regions when not in an air conditioned environment. Simply enough, the concern is to keep the electrostatic panels dust free. Humidity will combine with any dust on the panel to make it slightly conductive. This will result in a slight pathway for the charge to leave the membrane of the speaker. The solution is simple. They only require occasional vacuuming with a strong vacuum hose. You will have best results when the speakers have been unplugged for six hours or overnight. We are confident that they will serve you very well.

**Should I unplug my speakers during a thunderstorm?**

Yes, or before. It's a good idea to disconnect all of your audio/video components during stormy weather.

# TROUBLESHOOTING

---

## **No Output**

- Check that all your system components are powered on.
- Check your speaker wires and connections.
- Check all interconnecting cables.

## **Weak Output, Loss of Highs**

- Check the power cord. Is it properly connected to the speaker?
- Is the Cinema properly adjusted towards the listening position?  
Read Installation (pages 6–7) for more information.

## **Popping and Ticking Sounds, Funny Noises**

- These occasional noises are harmless and will not hurt your audio system or your speakers. All electrostatic speakers are guilty of making odd noises at one time or another.
- These noises may be caused by dirt and dust particles collecting on the speaker or by high humidity.
- Dirt and dust may be vacuumed off with a brush attachment connected to your vacuum cleaner, or you may blow them off with compressed air.



## Specifications

The Cinema hybrid speaker system consists of a broad-range single element electrostatic transducer integrated with a quick-response woofer. This approach takes advantage of the benefits that both technologies have to offer. Dispersion is a controlled 30 degrees. This was achieved by curving the electrostatic transducer element itself, an elegantly simple solution.

### System Frequency Response

80–20,000 Hz  $\pm$  3 dB

### Sensitivity

89 dB/2.83 volts/meter

### Impedance

6 ohms, 3.7 ohms @ 20 kHz

### Crossover Frequency

300, 3500 Hz

### Woofer Type

Two 5.25" (13cm) magnetically shielded in a sealed cabinet

### CLS™ Mid-Range

Patented CLS™ electrostatic transducer

### High Frequency Driver

Vacuum formed 1" soft dome

### Power Handling

150 watts rms

### Weight

28 lbs. each (12.7 kg)

### Size

33.5" inches W  $\times$  8" inches D  $\times$  10.5" inches H  
(85cm W  $\times$  20cm D  $\times$  27cm H)

### Size With Stand

33.5" inches W  $\times$  10" inches D  $\times$  10.5" inches H  
(85cm W  $\times$  25.4cm D  $\times$  27cm H)

## Warranty and Registration

*Your Cinema speaker is provided with an automatic Limited 90 Day Warranty coverage.*

You have the option, at no additional charge, to receive a Limited 5 Year Warranty coverage. To obtain the Limited 5 Year Warranty coverage you need to complete and return the Certificate of Registration, included with your speakers, and provide a copy of your dealer receipt, to MartinLogan within 30 days of purchase.

*MartinLogan may not honor warranty service claims unless we have a completed Warranty Registration card on file!*

If you did not receive a Certificate of Registration with your new Cinema speaker you cannot be assured of having received new units. If this is the case, please contact your authorized MartinLogan dealer.

## Service

Should you be using your MartinLogan product in a country other than the one in which it was originally purchased, we ask that you note the following:

1. The appointed MartinLogan distributor for any given country is responsible for warranty servicing only on units distributed by or through it in that country in accordance with its applicable warranty.
2. Should a MartinLogan product require servicing in a country other than the one in which it was originally purchased, the end user may seek to have repairs performed by the nearest MartinLogan distributor, subject to that distributor's local servicing policies, but all cost of repairs (parts, labor, transportation) must be born by the owner of the MartinLogan product.
3. If, after owning your speakers for six months, you relocate to a country other than the one in which you purchased your speakers, your warranty may be transferable. Contact MartinLogan for details.

# GLOSSARY OF AUDIO TERMS

---

**AC.** Abbreviation for alternating current.

**Active crossover.** Uses active devices (transistors, ICs, tubes) and some form of power supply to operate.

**Amplitude.** The extreme range of a signal. Usually measured from the average to the extreme.

**Arc.** The visible sparks generated by an electrical discharge.

**Bass.** The lowest frequencies of sound.

**Bi-Amplification.** Uses an electronic crossover, or line-level passive crossover, and separate power amplifiers for the high and low frequency loudspeaker drivers.

**Capacitance.** That property of a capacitor which determines how much charge can be stored in it for a given potential difference between its terminals, measured in farads, by the ratio of the charge stored to the potential difference.

**Capacitor.** A device consisting of two or more conducting plates separated from one another by an insulating material and used for storing an electrical charge. Sometimes called a condenser.

**Clipping.** Distortion of a signal by its being chopped off. An overload problem caused by pushing an amplifier beyond its capabilities. The flat-topped signal has high levels of harmonic distortion which creates heat in a loudspeaker and is the major cause of loudspeaker component failure.

**Crossover.** An electrical circuit that divides a full bandwidth signal into the desired frequency bands for the loudspeaker components.

**dB (decibel).** A numerical expression of the relative loudness of a sound. The difference in decibels between two sounds is ten times the Base 10 logarithm of the ratio of their power levels.

**DC.** Abbreviation for direct current.

**Diffraction.** The breaking up of a sound wave caused by some type of mechanical interference such as a cabinet edge, grill frame or other similar object.

**Diaphragm.** A thin flexible membrane or cone that vibrates in response to electrical signals to produce sound waves.

**Distortion.** Usually referred to in terms of total harmonic distortion (THD) which is the percentage of unwanted harmonics of the drive signal present with the wanted signal. Generally used to mean any unwanted change introduced by the device under question.

**Driver.** See transducer.

**Dynamic Range.** The range between the quietest and the loudest sounds a device can handle (often quoted in dB).

**Efficiency.** The acoustic power delivered for a given electrical input. Often expressed as decibels/watt/meter (dB/w/m).

**ESL.** Abbreviation for electrostatic loudspeaker.

**Headroom.** The difference, in decibels, between the peak and RMS levels in program material.

**Hybrid.** A product created by the marriage of two different technologies. Meant here as the combination of a dynamic woofer with an electrostatic transducer.

**Hz (Hertz).** Unit of frequency equivalent to the number of cycles per second.

**Imaging.** To make a representation or imitation of the original sonic event.

**Impedance.** The total opposition offered by an electric circuit to the flow of an alternating current of a single frequency. It is a combination of resistance and reactance and is measured in ohms. Remember that a speaker's impedance changes with frequency, it is not a constant value.

---

**Inductance.** The property of an electrical circuit by which a varying current in it produces a varying magnetic field that introduces voltages in the same circuit or in a nearby circuit. It is measured in henrys.

**Inductor.** A device designed primarily to introduce inductance into an electrical circuit. Sometimes called a choke or coil.

**Linearity.** The extent to which any signal handling process is accomplished without amplitude distortion.

**Midrange.** The middle frequencies where the ear is the most sensitive.

**Passive crossover.** Uses no active components (transistors, ICs, tubes) and needs no power supply (AC, DC, battery) to operate. The crossover in a typical loudspeaker is of the passive variety. Passive crossovers consist of capacitors, inductors and resistors.

**Phase.** The amount by which one sine wave leads or lags a second wave of the same frequency. The difference is described by the term phase angle. Sine waves in phase reinforce each other; those out of phase cancel.

**Pink noise.** A random noise used in measurements, as it has the same amount of energy in each octave.

**Polarity.** The condition of being positive or negative with respect to some reference point or object.

**RMS.** Abbreviation for root mean square. The effective value of a given waveform is its RMS value. Acoustic power is proportional to the square of the RMS sound pressure.

**Resistance.** That property of a conductor by which it opposes the flow of electric current, resulting in the generation of heat in the conducting material, usually expressed in ohms.

**Resistor.** A device that is used in a circuit primarily to provide resistance.

**Resonance.** The effect produced when the natural vibration frequency of a body is greatly amplified by reinforcing vibrations at the same or nearly the same frequency from another body.

**Sensitivity.** The volume of sound delivered for a given electrical input.

**Stator.** The fixed part forming the reference for the moving diaphragm in a planar speaker.

**THD.** The abbreviation for total harmonic distortion. (See Distortion.)

**TIM.** The abbreviation for transient intermodulation distortion. (See Distortion.)

**Transducer.** Any of various devices that transmit energy from one system to another, sometimes one that converts the energy in form. Loudspeaker transducers convert electrical energy into mechanical motion.

**Transient.** Applies to that which lasts or stays but a short time. A change from one steady-state condition to another.

**Tweeter.** A small drive unit designed to produce only high frequencies.

**Wavelength.** The distance measured in the direction of progression of a wave, from any given point characterized by the same phase.

**White noise.** A random noise used in measurements, as it has the same amount of energy at each frequency.

**Woofers.** A drive unit operating in the bass frequencies only. Drive units in two-way systems are not true woofers but are more accurately described as being mid/bass drivers.

c l s e l e c t r o s t a t i c  
  
**MARTIN LOGAN**

2101 Delaware Street, Lawrence, Kansas 66046, USA tel 785.749.0133 fax 785.749.5320 [www.martinlogan.com](http://www.martinlogan.com)